

Series 2700 Fabric Door Canopy

It is our recommendation that you read instructions carefully prior to assembly and installation.

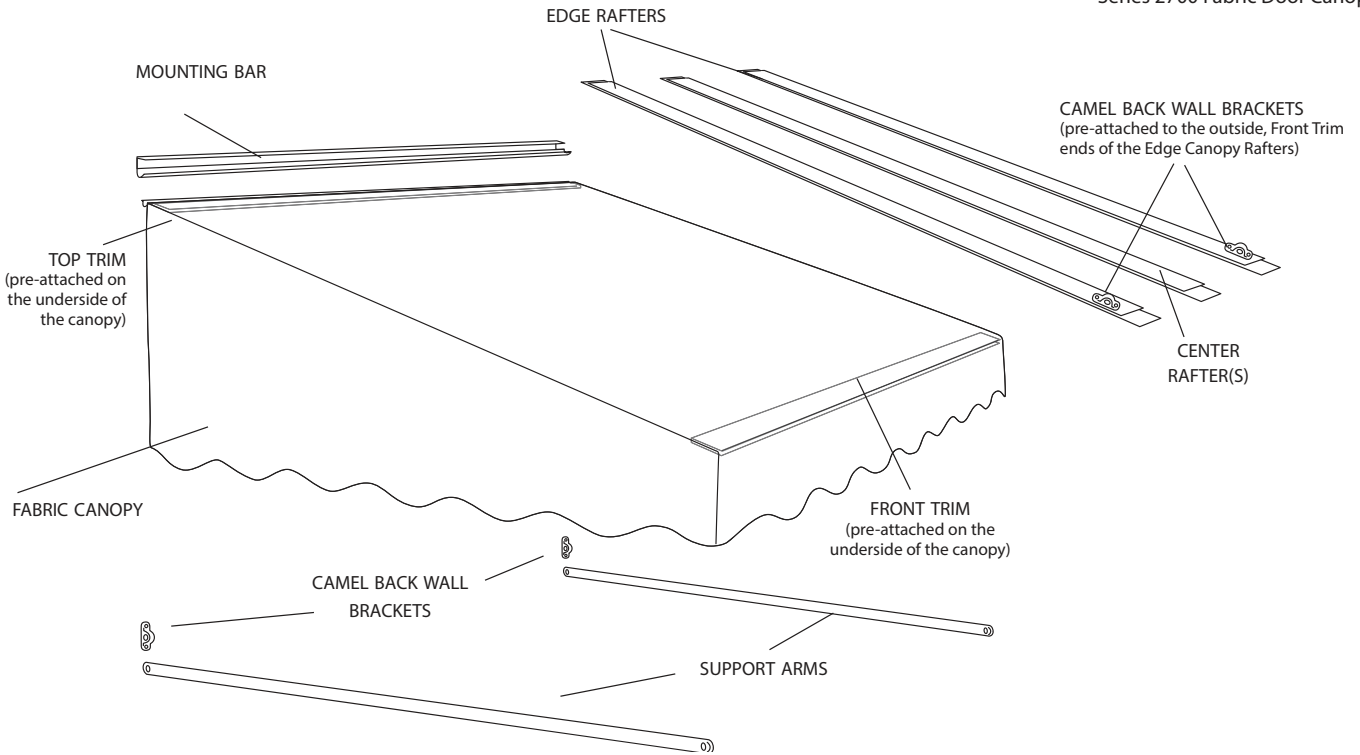

Series 2700 Fabric Door Canopy



Series 2700 Parts Check List:

- | | | | |
|--|---|---|--|
| <input type="checkbox"/> Fabric Canopy | <input type="checkbox"/> Edge Rafters (2) | <input type="checkbox"/> Support Arms* | <input type="checkbox"/> Small Screws* |
| <input type="checkbox"/> Top Trim (attached) | <input type="checkbox"/> Center Rafter(s) | <input type="checkbox"/> Camel Back Wall Brackets* | <input type="checkbox"/> Large Screws* |
| <input type="checkbox"/> Front Trim (attached) | <input type="checkbox"/> Mounting Bar | <input type="checkbox"/> Machine Screws (its tip is flat) | |

*QUANTITIES & SIZE OF PARTS MAY VARY BY AWNING SIZE AND MODEL SERIES

Actual Size - End Views of Canopy parts for easy reference and assembly:

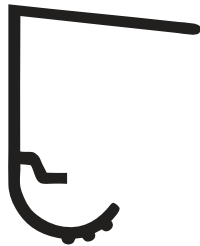

Mounting Bar



Top Trim



Front Trim



Edge & Center Canopy Rafter

Required Tools:

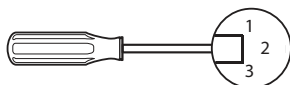

Phillips, Regular & 1/4" Hex Head
Screwdrivers or Drill Bits

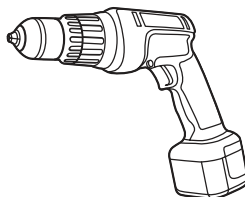

Power Drill

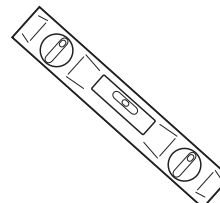

Level

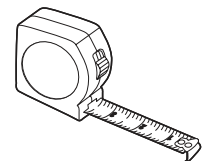

Tape Measure

Assembly Instructions

Series 2700 Fabric Door Canopy

1

Hardware Pack

Canopy Pack

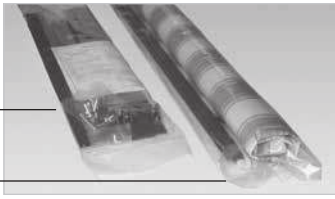

FIG. 1

The Series 2700 Fabric Door Canopy comes packaged in two separate plastic bags: Bag one contains the hardware and instructions; bag two contains the canopy with three frame pieces, a Mounting Bar, Top Trim and Front Trim. For your convenience, the Front Trim and Top Trim frame parts are already attached to the canopy.

2

Mounting Bar

The Front Trim and the Top Trim are pre-attached with the Mounting Bar rolled in loose

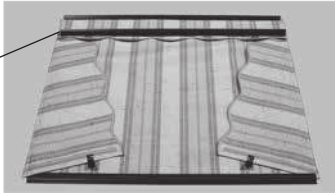

FIG. 2

The canopy will come rolled with the top or outside rolled to the inside. Unroll the canopy. (The Mounting Bar is rolled inside the canopy and will be used in Step 1 of this manual's *Installation Instructions*. Set it aside for now.) Open the sides and flip the whole canopy over. The canopy will be assembled from this position, **upside (or topside) down** and **inside (or underside) up**. The Top Trim and Front Trim frame pieces are already attached.

3

Support Arm

Camel Back Wall Bracket

Edge Rafter

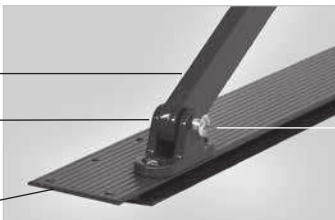

FIG. 3

To begin, attach one end of one of the Support Arms to the Edge Rafter by inserting it into the Camel Back Wall Bracket that is already mounted on the Edge Rafter using a machine screw.

*NOTE: Insert the machine screws through the Camel Back Wall Bracket and the Support Arms **from the outside in**, toward the canopy.*

4

Support Arm with Camel Back Wall Bracket

Edge Rafter



Front Trim FIG. 4

Attach one Edge Rafter to the Front Trim using small screws in pre-punched holes; the Front Trim is behind the valance on the inside of the canopy and is pre-attached.

NOTE: Be sure to position the Edge Rafters so that the ends with the attached Camel Back Wall Bracket/Support Arm are toward the outside and at the front of the canopy (Front Trim).

5

Top Trim

Edge Rafter

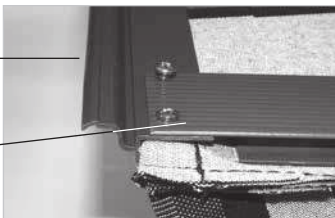

FIG. 5

Attach the other end of the Edge Rafter to the Top Trim on both sides using two small screws in pre-punched holes.

Repeat Steps 3, 4 and 5 for the second Support Arm and secure the other Edge Rafter on the other side of the canopy.

6

Center Rafter

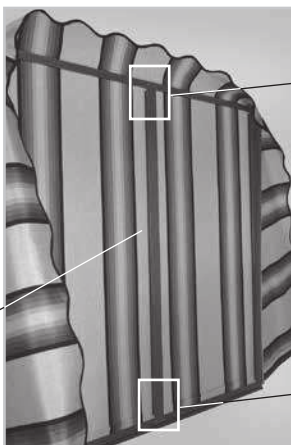

FIG. 6



INSET 6A
Center Rafter to Front Trim



INSET 6B
Center Rafter to Top Trim

Position the Center Rafter(s) and align with pre-punched holes at the Front Trim and the Top Trim. Then, fasten the Center Rafter to the Front Trim first and then the Top Trim with two small screws at each end (FIG. 6).

Your canopy is now ready for installation.

(INSETS 6A & 6B) The Fabric Canopy is turned vertically to show placement of Center Rafter with attachment details to the Front Trim and Top Trim.



SERIES 2700
Door Canopy

Installation Instructions

1

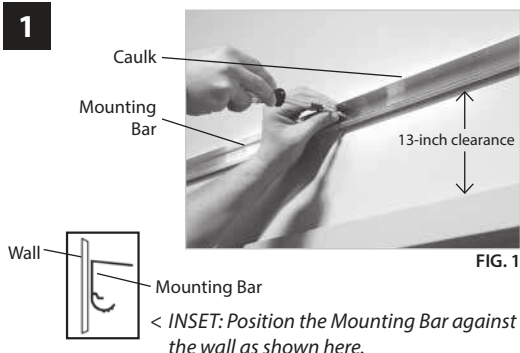

Install Mounting Bar with large screws 13" above the door.

Be sure the bar is level and centered over the door opening. Screws must be in studs or heavy sheathing. (Drill alternate holes in bar if necessary.) Please refer to FIG. 1 INSET to place the Mounting Bar correctly on the wall.

! Caulk the top of the Mounting Bar against the house.

2

Lift the front of the canopy upward and insert the Top Trim into the Mounting Bar (FIG. 2A). Lower front of canopy slowly and allow Sides and Support Arms to rest on the house (FIG. 2B); be sure the two parts are completely interlocked. Align holes and secure Top Trim to Mounting Bar with small screws from bottom side (FIG. 2C).

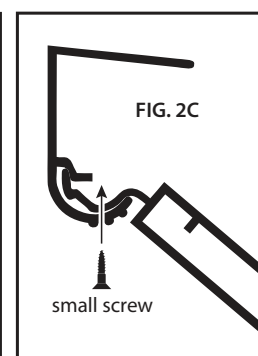
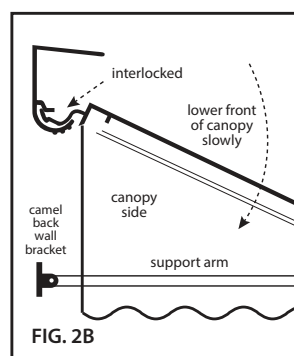
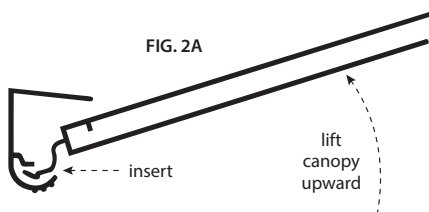

3

(Front) - Canopy Frame Views - (Side)

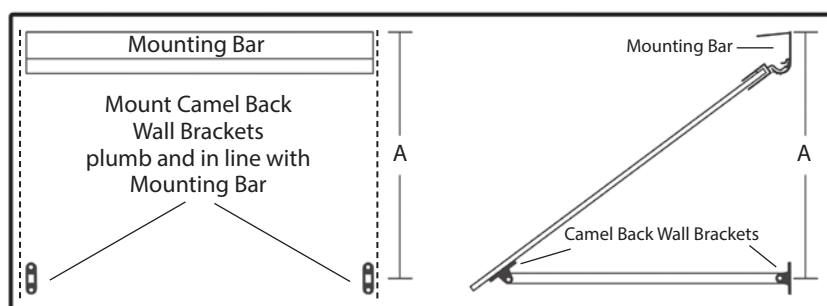

Temporarily attach the two loose Camel Back Wall Brackets to the other end of the Support Arms using machine screws.

Before securing Support Arms with Camel Back Wall Brackets to your house, please refer to the mounting chart to the left for model number and correct mounting points for your canopy.

NOTE: Mounting dimension 'A' is measured from the top of the Mounting Bar to the center of the Camel Back Wall Brackets (see chart).

Now, attach mounting brackets to the house using large screws, making sure the Camel Back Wall Brackets are secured in solid sheathing at the proper points from the reference chart.

Door Canopy Mounting Chart

Model Number	4	5	6	7	8
Mounting Point	7-1/2"	9"	10-1/2"	12"	13-1/2"

4



After Camel Back Wall Brackets have been secured to the house, remove the machine screws and re-insert them through grommeted tabs on your canopy to secure the canopy sides, and screw them back into the Camel Back Wall Brackets.

Installation of your Series 2700 Fabric Door Canopy is now complete.