

# Series 3300 Fabric Window Awning with Support Arms

*It is our recommendation that you read instructions carefully prior to assembly and installation.*

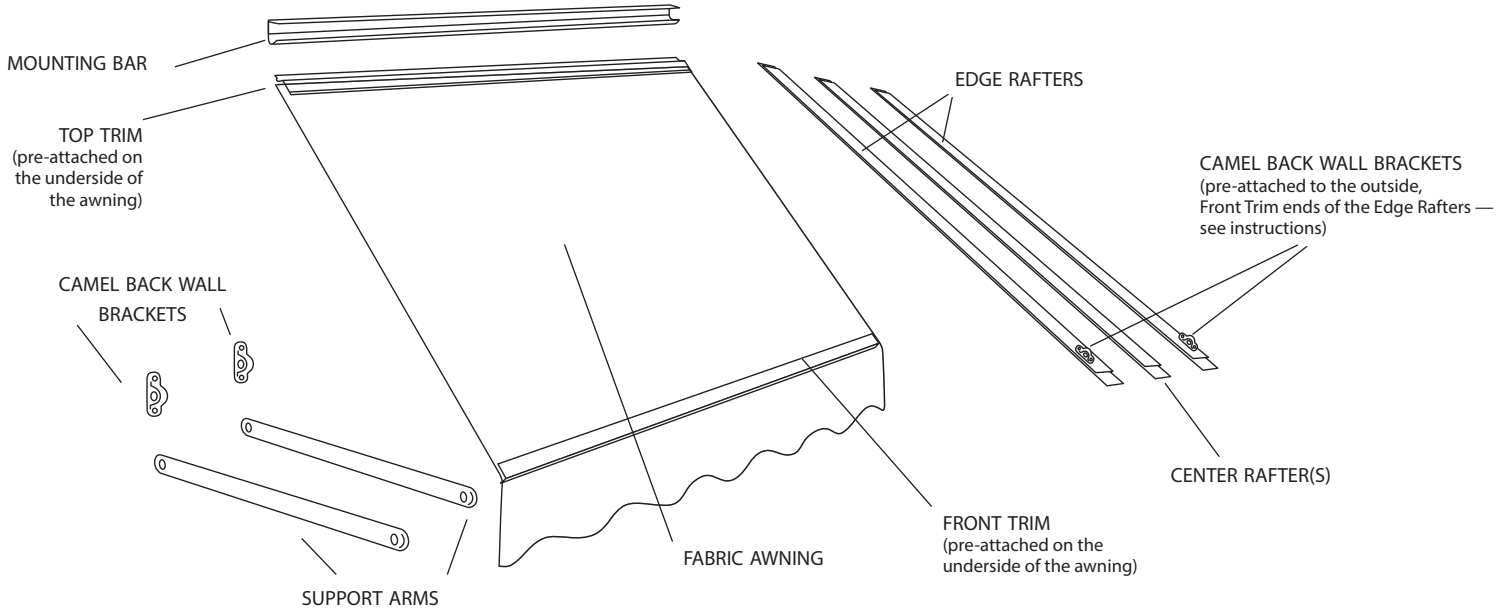

Series 3300 with Support Arms



## Series 3300 Parts Check List:

- |  |  |  |  |
|--|--|--|--|
| <input type="checkbox"/> Fabric Awning         | <input type="checkbox"/> Edge Rafters (2)  | <input type="checkbox"/> Support Arms*                     | <input type="checkbox"/> Small Screws* |
| <input type="checkbox"/> Top Trim (attached)   | <input type="checkbox"/> Center Rafter(s)* | <input type="checkbox"/> Camel Back Wall Brackets*         | <input type="checkbox"/> Large Screws* |
| <input type="checkbox"/> Front Trim (attached) | <input type="checkbox"/> Mounting Bar      | <input type="checkbox"/> Machine Screws (its tip is flat)* |  |

*\*QUANTITIES & SIZE OF PARTS MAY VARY BY AWNING SIZE AND MODEL SERIES*

## Actual Size - End Views of Awning parts for easy reference and assembly:



Mounting Bar



Top Trim



Front Trim



Edge & Center Rafter

## Required Tools:

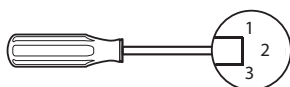

Phillips, Regular & 1/4" Hex Head  
Screwdrivers or Drill Bits

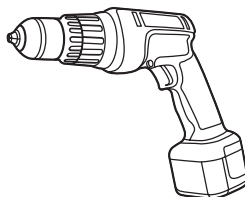

Power Drill

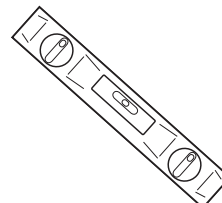

Level

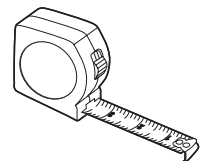

Tape Measure

# Assembly Instructions

## Series 3300 Fabric Window Awning with Support Arms

1

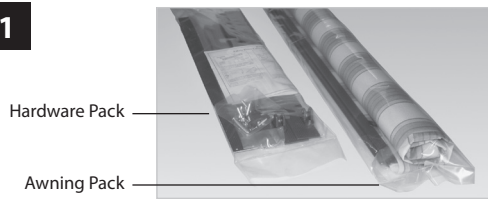

Series 3300 Fabric Window Awning comes packaged in two separate plastic bags: Bag one contains the hardware and instructions; bag two contains the awning with three frame pieces, a Mounting Bar, Top Trim and Front Trim. For your convenience, the Front Trim and Top Trim frame parts are already attached to the awning.

2

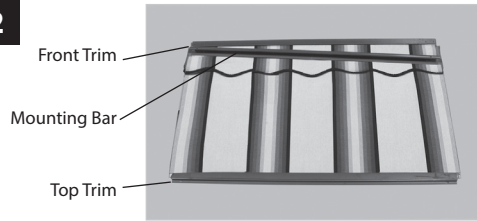

The 3300 will come rolled with the top or outside rolled to the inside. Unroll the awning and flip the entire awning over. (The Mounting Bar is rolled inside the awning and will be used in Step 1 of this manual's *Installation Instructions*. Set it aside for now.) The awning will be assembled from this position, **upside (or topside) down and inside (or underside) up**. The Top Trim and Front Trim frame pieces are already attached.

3

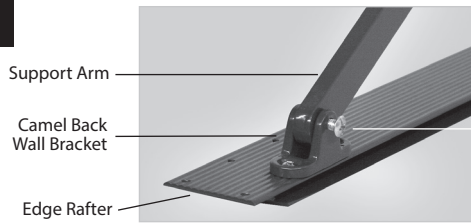

Attach one end of one of the Support Arms to the Edge Rafter by inserting it into the Camel Back Wall Bracket that is already mounted on the Edge Rafter using a machine screw.

*NOTE: Insert the machine screws through the Camel Back Wall Bracket and Support Arms (as shown) **from the outside in**, toward the awning.*

4

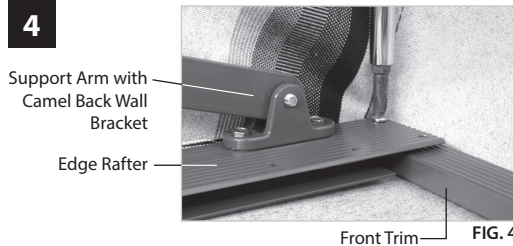

Attach one Edge Rafter to the Front Trim using small screws in pre-punched holes — the Front Trim is behind the valance on the inside of the awning and is pre-attached.

*NOTE: Be sure to position the Edge Rafters so that the ends with the attached Camel Back Wall Bracket/Support Arm is toward the outside and at the front of the awning connecting to Front Trim.*

5

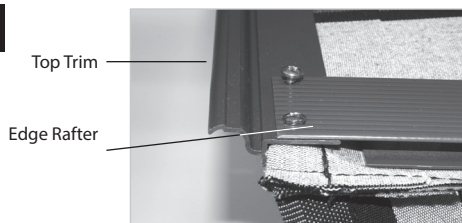

Attach the other end of the Edge Rafter to the Top Trim on both sides using two small screws in pre-punched holes. Repeat Steps 3, 4 and 5 for the second Support Arm and secure the other Edge Rafter on the other side of the awning.

6

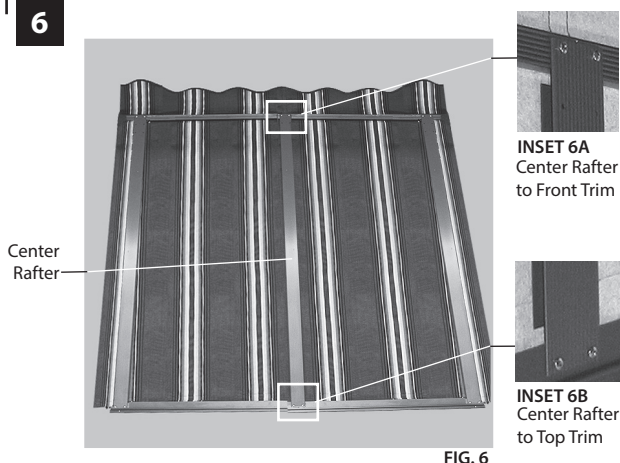

Position the Center Rafter(s) and align with pre-punched holes at the Front Trim and the Top Trim. Then, fasten the Center Rafter to the Front Trim first and then the Top Trim with two small screws at each end (FIG. 6).

Your awning is now ready for installation.

*(INSETS 6A & 6B) The Fabric Awning is turned vertically to show placement of Center Rafter with attachment details to the Front Trim and Top Trim.*

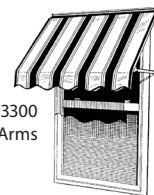

SERIES 3300  
with Support Arms

# Installation Instructions

1

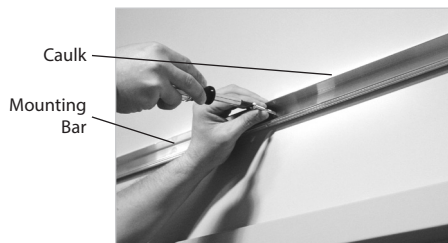
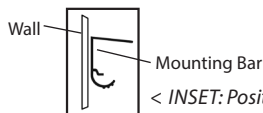

FIG. 1

Install Mounting Bar with large screws above the window. Be sure the bar is level and centered over the window opening. Screws must be in studs or heavy sheathing. (Drill alternate holes in bar if necessary.)

**!** *Caulk the top of the Mounting Bar against the house.*



< INSET: Position the Mounting Bar against the wall as shown here.

2

Lift the front of the awning upward and insert the Top Trim into the Mounting Bar (FIG. 2A). Lower the front of the awning slowly and allow Support Arms to rest on the house (FIG. 2B); be sure the two parts are completely interlocked. Align holes and secure Top Trim to Mounting Bar with small screws from bottom side (FIG. 2C).

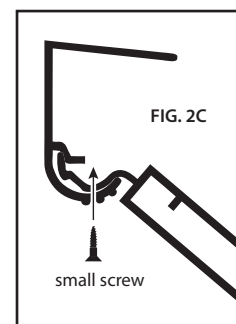
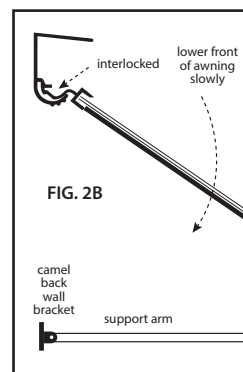
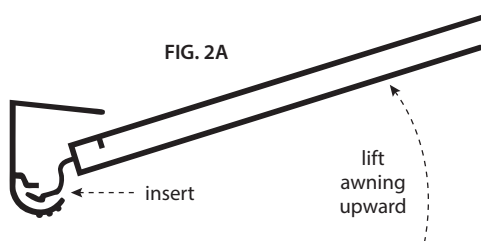

3

(Front) - Awning Frame Views - (Side)

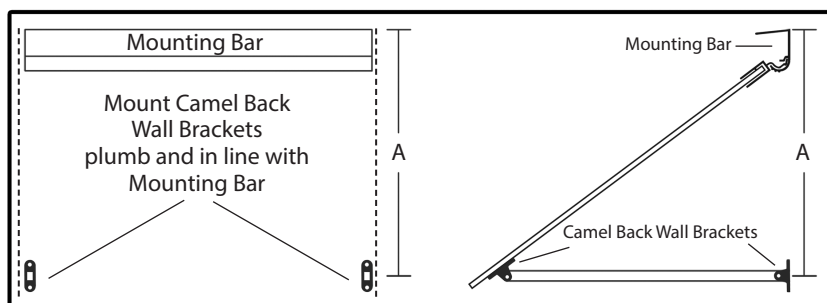

Temporarily attach the two loose Camel Back Wall Brackets to the other end of the Support Arms using machine screws.

Before securing Support Arms with Camel Back Wall Brackets to your house, please refer to the mounting chart to the left for model number and correct mounting points for your awning.

*NOTE: Mounting dimension 'A' is measured from the top of the Mounting Bar to the center of the Camel Back Wall Brackets (see chart).*

Now attach Mounting Brackets to the house using large screws, making sure the Camel Back Wall Brackets are secured in solid sheathing at the proper points from the reference chart. Use a level for proper alignment of the Support Arm.

Window Awning Mounting Chart

Model Number	4	5	6	7	8
Mounting Point	13-3/4"	17-1/2"	21-3/4"	26-1/2"	31-3/4"

All mounting points are approximate.