

Series 3500 Aluminum Window Awning with Sidewings

It is our recommendation that you read instructions carefully prior to assembly and installation.

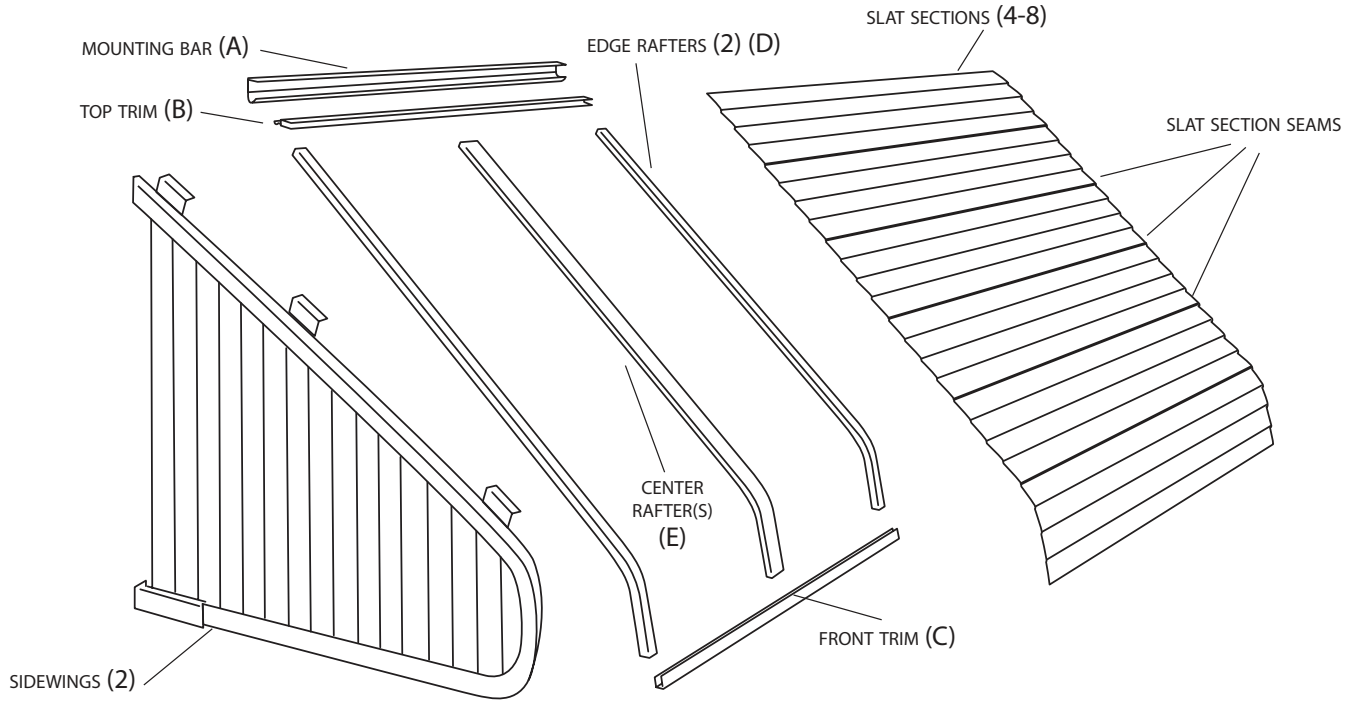

Series 3500 with Sidewings



Series 3500 Parts Check List:

- | | | | |
|---------------------------------------|--|---|--|
| <input type="checkbox"/> Mounting Bar | <input type="checkbox"/> Edge Rafters (2) | <input type="checkbox"/> Sidewings | <input type="checkbox"/> Small Screws* |
| <input type="checkbox"/> Top Trim | <input type="checkbox"/> Center Rafter(s)* | <input type="checkbox"/> Interlock Clips* | <input type="checkbox"/> Large Screws* |
| <input type="checkbox"/> Front Trim | <input type="checkbox"/> Slat Section Assembly | | |

*QUANTITIES & SIZE OF PARTS MAY VARY BY AWNING SIZE AND MODEL SERIES

Actual Size End Views of Awning parts for easy reference and assembly:

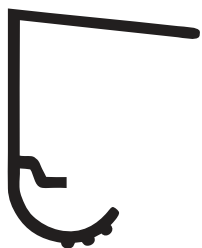

Mounting Bar (A)



Top Trim (B)



Front Trim (C)



Edge Rafter (D)



Center Rafter (E)

Required Tools:

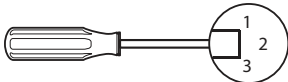

Phillips, Regular & 1/4" Hex Head
Screwdrivers or Drill Bits

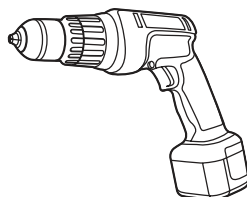

Power Drill

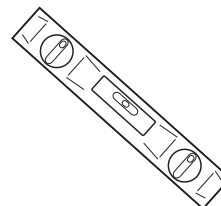

Level

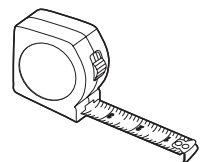

Tape Measure

1

Slats have a slight curve to them. Keep them this way for assembly.

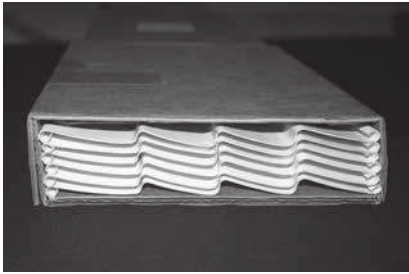

FIG. 1A

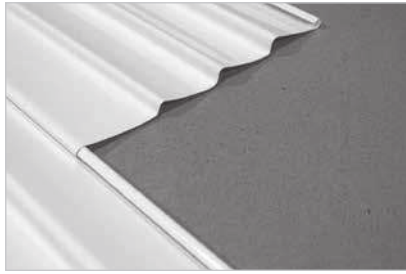

FIG. 1B

The awning is assembled upside down. Note that the **Slat Sections** are packaged upside down (FIG. 1A). Assemble on a flat surface.

CAUTION: Awning parts may have sharp edges. Use care in assembly.

Lay the first slat out, curled edge **DOWN** on your left with ends toward you. Slide each subsequent slat into the curled **UP** edge on the right (FIG. 1B).

2



FIG. 2

While keeping Slat Sections **flush with each other**, crimp slats together at each seam interlock with a pair of channel lock pliers about 1/4 inch in from the edge (not too much — only enough to secure them together). Be sure to keep the plier teeth level with slats so that you do not accidentally bend them up while crimping.

3

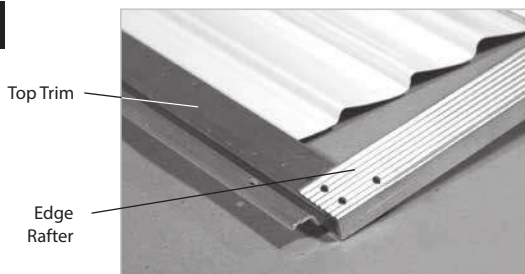

FIG. 3

Slide the Top Trim out from Slat Section about 2 inches to provide clearance. Next, slide the non-curved end of the Edge Rafter onto Top Trim, making sure the opposite, curved end of the Edge Rafter is up.

Next, slide both Top Trim and Edge Rafter back toward Slat Section and push Edge Rafter onto Slat Section edge evenly until Slat Section and the Top Trim are completely **FLUSH** into Edge Rafter (FIG. 3).

TIP: Use the palm of your hand flat on slats pressing down and pulling toward you to help snug them into Edge Rafter.

4

FIG. 4A shows improper assembly. These parts are **NOT** flush and therefore will not align to fasten screws

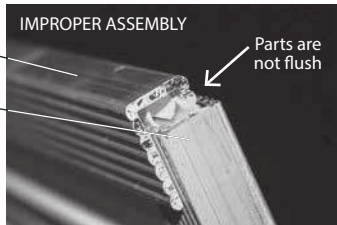

FIG. 4A

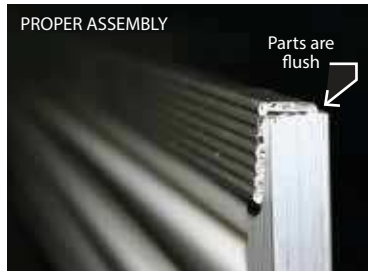

FIG. 4B

NOTE: It is very important that both ends of the awning (the top trim and the front trim) along with the slat section are **completely flush** in the edge rafters to be able to align pre-punched holes for fastening. See FIG. 4B.

Connect the Edge Rafter and Slat Section with the Front Trim. **Slat Section and Front Trim MUST be FLUSH in the Edge Rafter.** With Slat Section still secured **FLUSH** in Edge Rafter, slide Front Trim toward you and flush into the Edge Rafter, aligning pre-punched holes; it will fit snug.

NOTE: Only the outside edge of the Front Trim and the curled edge of the slat are inserted into the Edge Rafter (FIG. 4B).

Next, secure Top Trim and Front Trim with small screws in the larger pre-punched holes at **each end** of the Edge Rafter.

5



FIG. 5

Fasten small screws in the **two larger pre-punched holes** along Edge Rafter. (Pairs of **small holes** are for the installation of Sidewings.)

NOTE: Support the underside of the Slats Section and apply pressure while fastening screws. Repeat Edge Rafter assembly on the other side.

6

Center Rafter

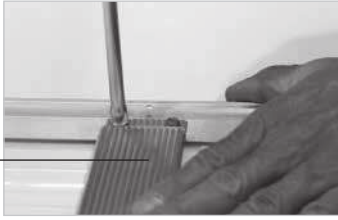

FIG. 6

Align Center Rafter with pre-punched holes in the center of the Top Trim first and secure with small screws, then do the same at the other end of the Center Rafter in the center on the Front Trim and secure with small screws.

NOTE: Window Awnings wider than 60" need more than one Center Rafter which will be provided. Pre-punched holes will guide installation of multiple Center Rafters.

7

Interlock Clip

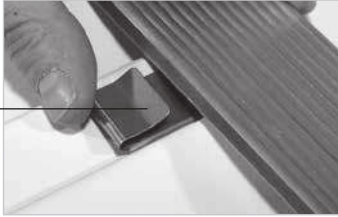

FIG. 7

Next, install Interlock Clips to secure frame to Awning: Connect Awning Slat Section Assembly to the Center Rafter frame using Interlock Clips at each joint where the slats interlock. Installing clips is a three-step process: (1) Find the slat joints; (2) Insert the curved part of clip into slat joint; (3) Slide clip onto Center Rafter. Interlock Clips are installed on the flat section of the awning only, not up on the curve. If stubborn, make sure they are straight and parallel with the slat joint.

8

Small Screws

Edge Rafter Connector



FIG. 8

Attach sidewings to Edge Rafters with small screws using pre-drilled holes.

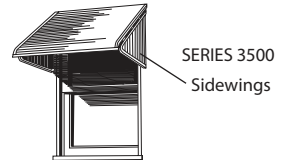

Installation Instructions

1

Caulk
Mounting Bar
Window Frame
Mounting Bar

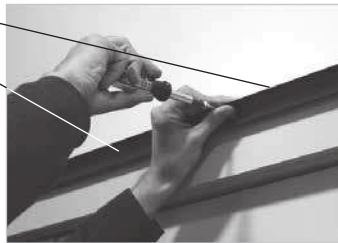

FIG. 1

Install Mounting Bar and secure with large screws on the window frame or in strong sheathing on the house around the window (if you measured for placement of your awning on the *outside* of the window frame). In this case, install the Mounting Bar on the house above the window frame.

Be sure the Mounting Bar is level and centered over the opening.

! *Caulk the top of the Mounting Bar against the house.*

2

Lift the front of the awning upward and insert the Top Trim into the Mounting Bar (FIG. 2A). Lower the front of the awning slowly and allow Sidewings to rest on the house (FIG. 2B); be sure the two parts are completely interlocked. Align holes and secure Top Trim to Mounting Bar with small screws from bottom side (FIG. 2C).

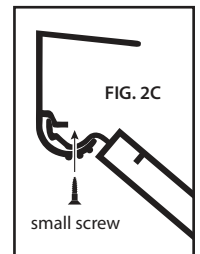
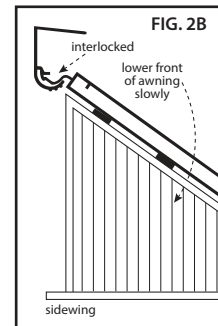
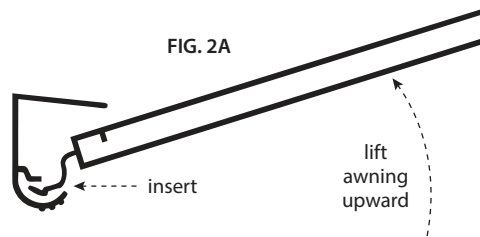

3

3500 Sidewing
Sidewing Mounting Bracket

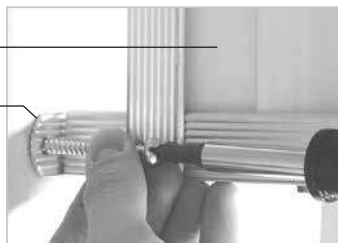

FIG. 3

Adjust Sidewings so they are vertically plumb. Attach Sidewings to house with large screws.

Installation of door canopy with Sidewings is now complete.