

Series 4700

Fabric Casement Window Awning with Sides



Series 4700 with Sides

It is our recommendation that you read instructions carefully prior to assembly and installation.

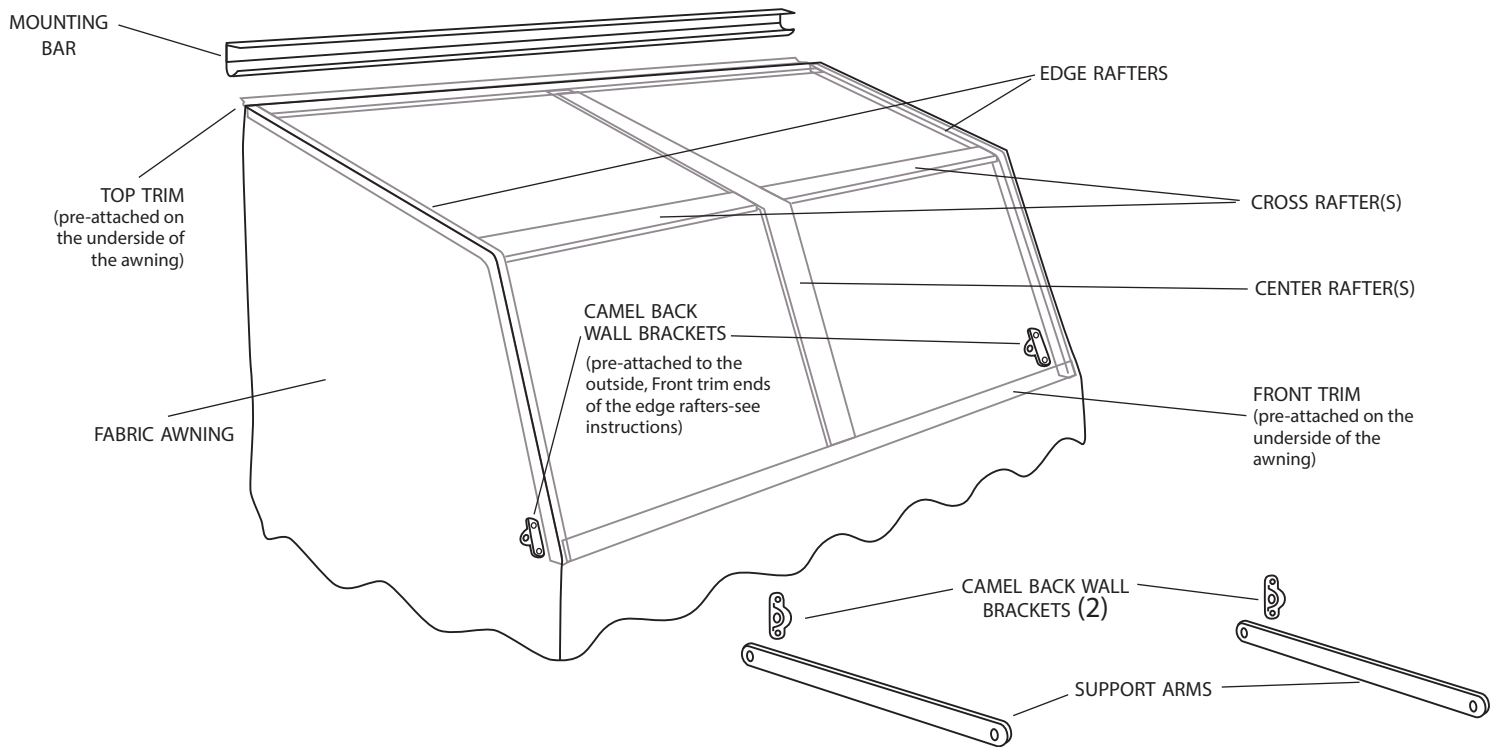

Series 4700 Parts Check List:

- | | | | |
|--|--|--|---|
| <input type="checkbox"/> Fabric Awning | <input type="checkbox"/> Edge Rafters (2) | <input type="checkbox"/> Cross Rafters* | <input type="checkbox"/> Small Screws* |
| <input type="checkbox"/> Top Trim (attached) | <input type="checkbox"/> Center Rafter(s)* | <input type="checkbox"/> Camel Back Wall Brackets* | <input type="checkbox"/> Large Screws* |
| <input type="checkbox"/> Front Trim (attached) | <input type="checkbox"/> Mounting Bar | <input type="checkbox"/> Support arms* | <input type="checkbox"/> Machine Screws (its tip is flat) |

*QUANTITIES INCREASE AS AWNING SIZES INCREASE.

Actual Size - End Views of Awning/Canopy parts for easy reference and assembly:

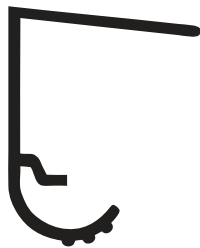

Mounting Bar



Top Trim



Front Trim



Edge & Center Rafter

Required Tools:

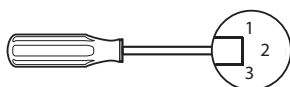

Phillips, Regular & 1/4" Hex Head
Screwdrivers or Drill Bits

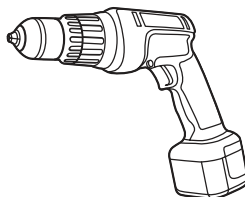

Power Drill

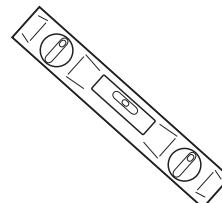

Level

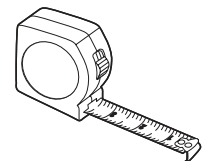

Tape Measure

Assembly Instructions

Series 4700 Fabric Casement Window Awning

1



FIG. 1

Series 4700 Fabric Casement Window Awning comes packaged in two separate plastic bags (FIG. 1): Bag one contains the hardware and instructions; bag two contains the awning with three frame pieces, a Mounting Bar, Top Trim and Front Trim. For your convenience, the Front Trim and Top Trim frame parts are already attached to the awning.

2

The Front Trim and the Top Trim are pre-attached with the Mounting Bar rolled in loose



FIG. 2A



Mounting Bar

FIG. 2B

The awning will come rolled with the top or outside rolled to the inside. Unroll the awning. (The Mounting Bar is rolled inside the awning and will be used in Step 1 of this manual's *Installation Instructions*. Set it aside for now.) Open the sides and flip the entire awning over. The awning will be assembled from this position, **upside (or topside) down** and **inside (or underside) up**. The Top Trim and Front Trim frame pieces are already attached.

3

Attach one end of each of the Support Arms to each Edge Rafter by inserting it into the Camel Back Wall Bracket (already attached) using machine screws.

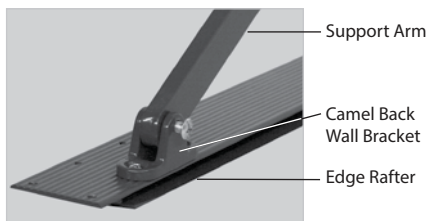

FIG. 3

*NOTE: Insert the machine screws through the Camel Back Wall Bracket and Support Arms (FIG. 3) **from the outside in**, toward the awning.*

4

Attach each Edge Rafter to the Front Trim using small screws in pre-punched holes.

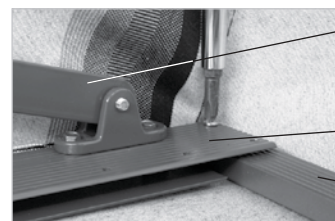
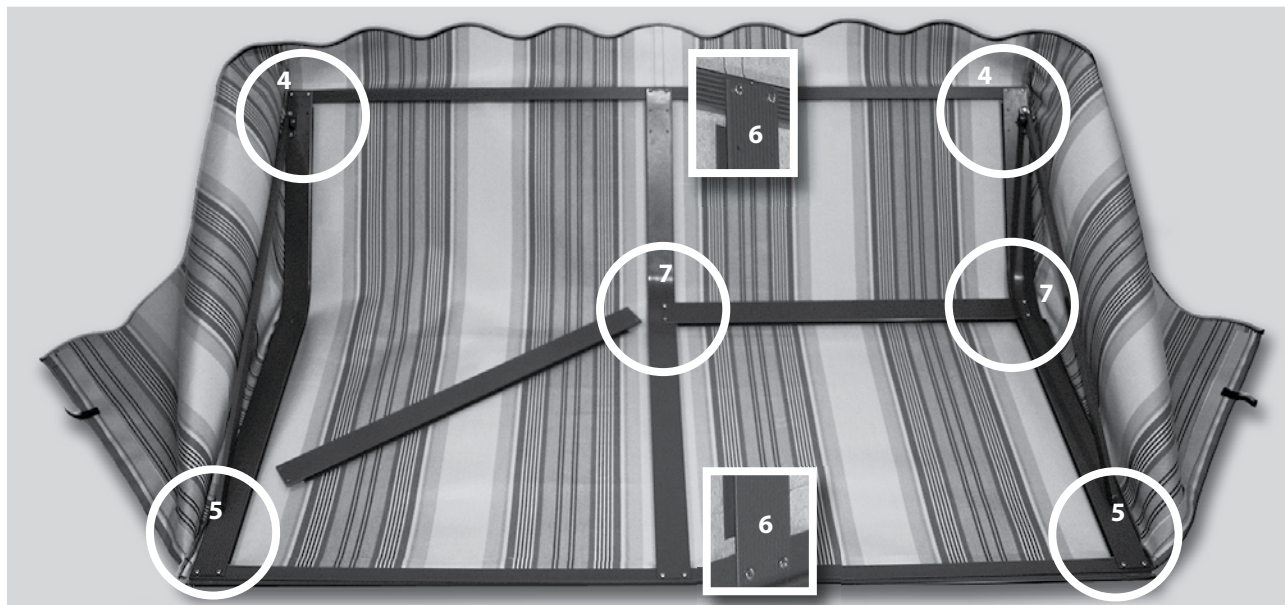

FIG. 4

NOTE: Be sure to position the Edge Rafters so that the end with the attached Camel Back Wall Bracket/Support Arm is toward the outside of the awning. This way, the end of the screw is toward the inside and will not wear on the fabric.



5

Top Trim
Edge Rafter

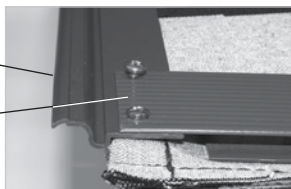

FIG. 5

Attach the other end of the Edge Rafter to the Top Trim (FIG. 5) using two small screws in pre-punched holes.

6

Awnings 47" wide and over require a Center Rafter: Attach Center Rafter to the Front Trim and to the Top Trim using two small screws in pre-punched holes.

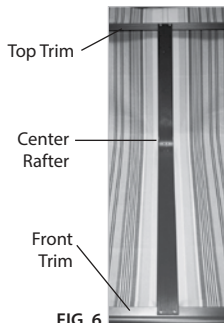

FIG. 6

7

Attach Cross Rafter(s) from Edge Rafter(s) to Center Rafter(s) and from Center Rafter(s) to Edge Rafter(s) (FIG. 7) using two small screws in pre-punched holes. (Awnings 46" wide and under have a 1-piece Cross Rafter.)

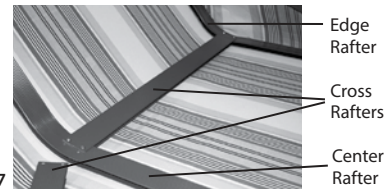

FIG. 7

Turn your awning top side up. It is now ready for installation.



SERIES 4700
with Sides

Installation Instructions

1

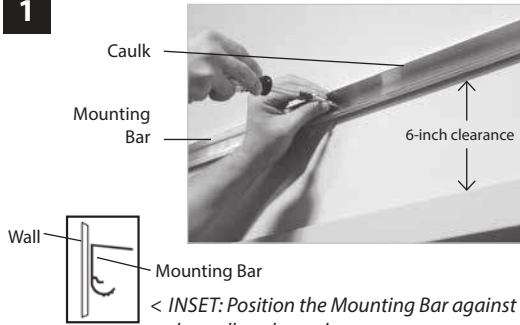

FIG. 1

Install Mounting Bar with large screws 6" above the window. Windows opening more than 18" will require additional mounting space.

Be sure the bar is level and centered over the window opening. Screws must be in studs or heavy sheathing. (Drill alternate holes in bar if necessary.)

Please refer to FIG. 1 INSET to place the Mounting Bar correctly on the wall.

! *Caulk the top of the mounting bar against the house.*

2

Lift the front of the awning upward and insert the Top Trim into the Mounting Bar (FIG. 2A). Lower the front of the awning slowly and allow Sides and Support Arms to rest on the house (FIG. 2B); be sure the two parts are completely interlocked. Align holes and secure Top Trim to Mounting Bar with small screws from bottom side (FIG. 2C).

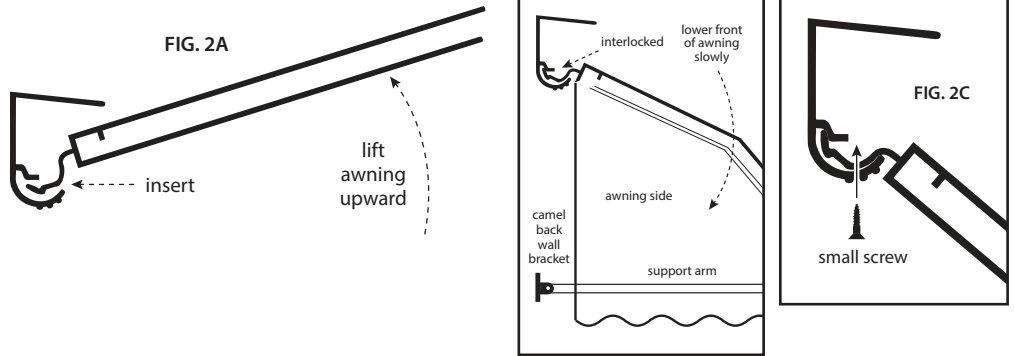
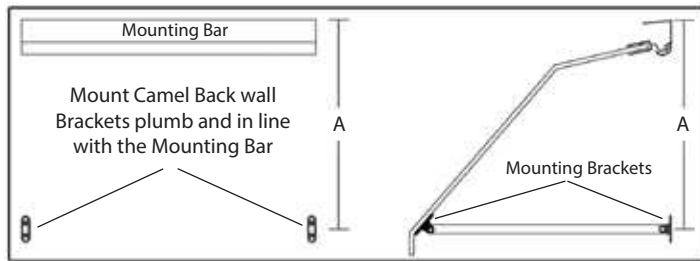

FIG. 2B

3



Temporarily attach the two loose Camel Back Wall Brackets to the other end of the Support Arms using machine screws.

Before securing Support Arms with Camel Back Wall Brackets to your house, please refer to the mounting chart on the left for model number and correct mounting points for your awning.

Now attach Mounting Brackets to the house using large screws, making sure the Camel Back Wall Brackets are secured in solid sheathing at the proper points from the reference chart.

NOTE:

Mounting dimension "A" is measured from the top of the Mounting Bar to the center of the Mounting Bracket (see chart).

Fabric Casement Window Awning Mounting Chart

Model Number	6	7	8	9
Mounting Point	17-1/2"	24"	29-1/4"	33-3/4"

All mounting points are approximate.

4



FIG. 4

After the Support Arms with Camel Back Wall Brackets have been secured to your house, remove the machine screws and re-insert them through grommeted tabs on the awning. Screw them back into the Camel Back Wall Brackets to secure the awning sides.

Installation is now complete.