

# OVERHEAD BRACE IMPERIAL MARQUEE 6" GUTTER

## BEFORE YOU BEGIN INSTALLATION:

**Consult your local building department for any required permits** You may be required to obtain a building permit for this structure. Contact your local building department for details.

**Read instructions thoroughly** Please read all instructions and notes carefully prior to assembly.

**A solid attachment is required for all existing structures.** All points of attachment to existing structures (such as house, deck, or patio) must be into solid, structurally sound, and secure material. Example: wood or metal studs, joists, headers, plates, or sills. Attachment may be made to block, concrete, brick, or stone veneer with suitable anchors, purchased separately. **Note:** Failure to properly fasten unit to wall, deck, porch, or patio may result in damage to the unit, damage to the structure it is attached to, and could cause serious bodily injury.

**Check for all parts** Use the Parts and Hardware List to check for any missing parts. To prevent scratching of painted materials, place on a tarp or other protective material.

**Assistance is recommended during entire assembly.**



## CAUTION

**Proper site preparation is required.**

**Standard shade structure design does not include additional loads such as hanging heavy plants, swings, or other objects.**

**DO NOT stand or sit on the shade structure roof.**

**Repair or replace broken parts immediately.**

**This kit contains parts with metal edges. Please be careful when handling.**

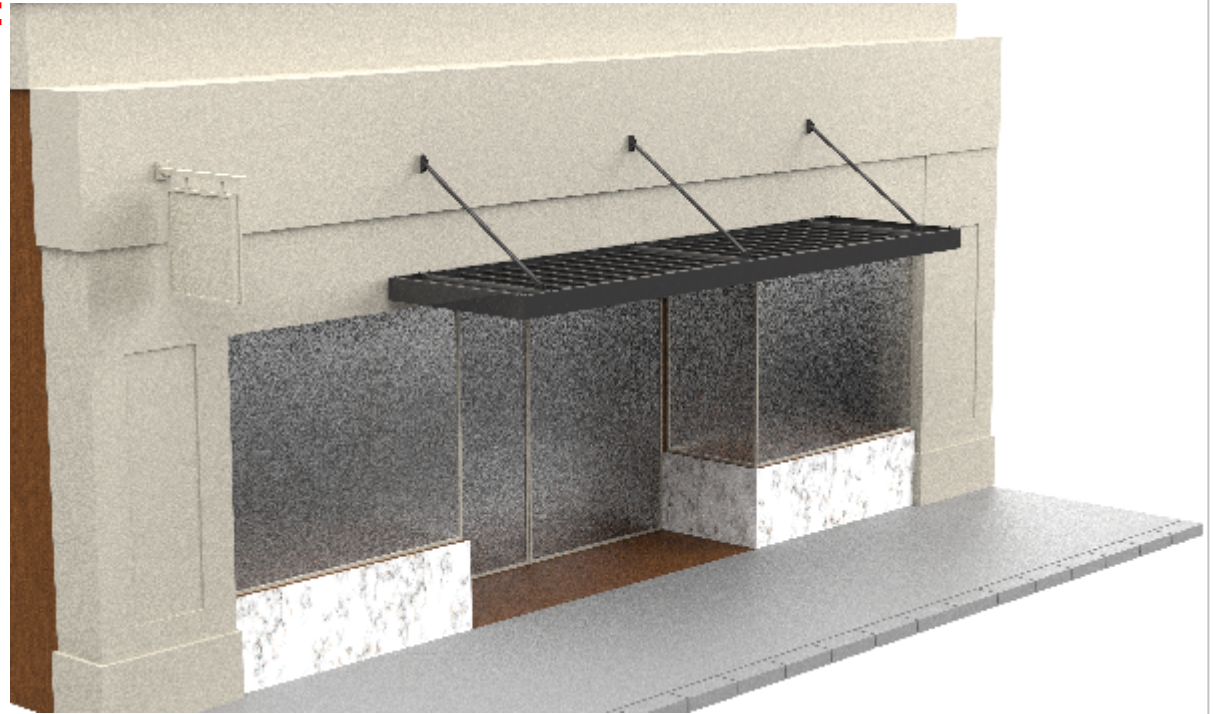

## SAFETY INFORMATION

Please read and understand this entire manual before attempting to assemble or install the product. Standard design for shade structures meets 20 lbs. per square foot live load and 115 miles per hour wind load based on the International Building Code (IBC) 2015 and American Society of Civil Engineers (ASCE) 7-10 design code. Engineering for greater load requirements is available; call 1-800-851-0865 for information. Local building codes should be verified before installation.

The design of the shade structure as set forth herein pertains only to the components and assemblies as manufactured by our company. The design of and attachment to supporting structural elements are outside the scope of this guide. It shall be the Owner and Installer's responsibility to provide sound supporting structure and attachment and to consult with qualified individuals where the design or verification of such components is required.

It shall be the Owner and Installer's responsibility to verify that local building code requirements are met and the proper permits are obtained prior to the installation. Professional engineering services may be required.



## INSTALLATION NOTES & TIPS:

- Complete site preparation before beginning assembly.
- DO NOT attempt to assemble on a day with strong winds.
- Have assistance nearby to lift and secure parts in place.
- Cutting and drilling metal components will cause shavings which must be carefully removed by sweeping or brushing. If this is not done, the metal shavings will rust and stain the surface finish.
- It is recommended to lower the speed of electric drills during this installation. Installing Tek screws at a high RPM may cause the Tek screws to become damaged or break during installation.
- Avoid over-driving, under-driving, or driving at an angle to properly install fasteners. Over-driven fasteners can depress the material and allow water to collect around the fastener, which will corrode the surface finish. Under-driven fasteners can cause leaks and may back out over time.
- The center-to-center spacing of the roof panel locks must be maintained as the panels are installed. If this is not done, problems may not show up until towards the end of the installation when parts may appear to be cut too short or too long. If this happens, check each roof panel spacing and re-set if necessary.
- We strongly recommend using a high grade sealant, such as our 100% silicone caulk and sealant. Caulking should be applied uniformly and without skips. A poor caulking job can cause leaks.

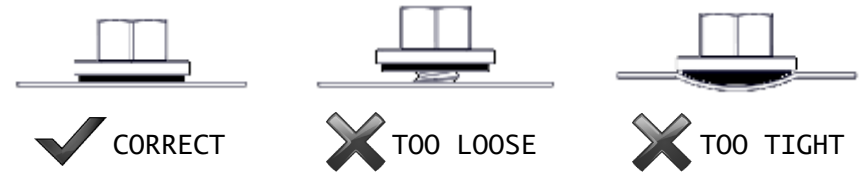

***Note:** These are basic installation guidelines for our standard load units and may not be suitable to your specific installation. It is important to follow all local and national building codes when installing any exterior improvement product.*

## TOOLS NEEDED FOR INSTALLATION

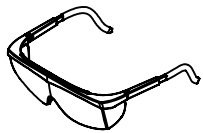

SAFETY GLASSES

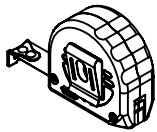

TAPE MEASURE

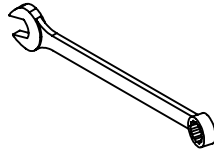

WRENCH  
9/16"  
7/8"

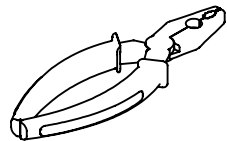

PLIERS

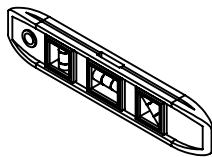

CARPENTERS LEVEL

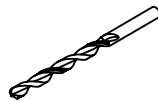

DRILL BIT  
SIZES: 1/8"  
5/16" 7/16"



SOCKET/HEX  
HEAD DRIVER  
SIZES: 1/4"



SOCKET/HEX  
HEAD DRIVER  
SIZES: 5/16"



SOCKET/HEX  
HEAD DRIVER  
SIZES: 9/16"



SOCKET/HEX  
HEAD DRIVER  
SIZES: 7/8"

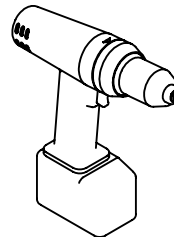

IMPACT DRILL  
ELECTRIC DRILL

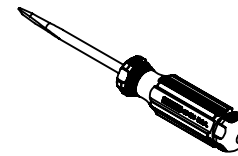

SCREW DRIVER  
FLAT & PHILLIPS

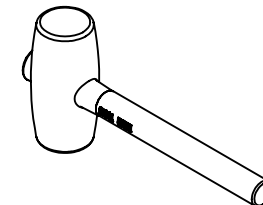

RUBBER MALLET

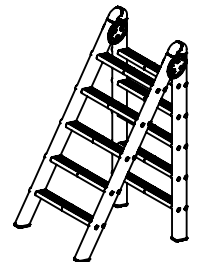

LADDER or  
ADJUSTABLE STILLTS

## RECOMMENDED TOOLS:

2X4 WOOD (BRACE)  
SILICONE CAULKING  
CARPENTERS' SQUARE  
METAL HACK SAW  
2" HOLE SAW  
3" HOLE SAW  
CHALK LINE  
GLOVES

# PARTS LIST

NOTE: LENGTH & QUANTITY OF PARTS WILL VARY BASED ON THE SIZE OF THE AWNING.

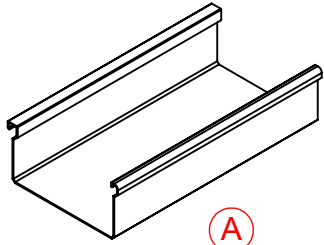

(A)

6" EXTRUDED FLAT ROOF PAN  
Part#: 11150

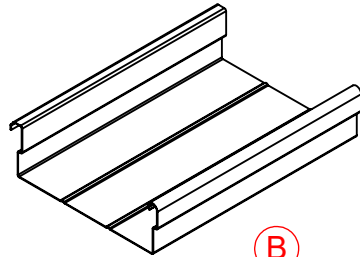

(B)

8" FLAT ROOF PAN  
Part#: 10212

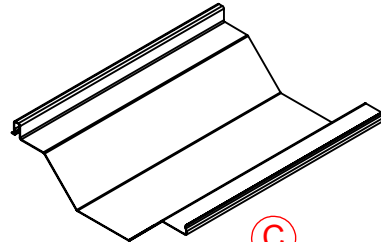

(C)

10" V-STYLE ROOF PAN  
Part#: 10116

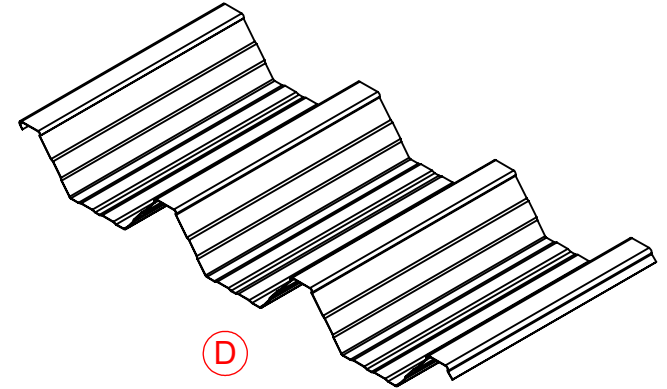

(D)

24" W-STYLE ROOF PAN  
Part#: 10307



(E)

WALL MOUNTING  
BRACKET  
Part#: 50128 or  
50178-HD

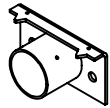

(F)

FASCIA FITTING  
BRACKET  
Part#: 50156

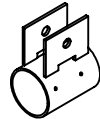

(G)

SLIDE FITTING  
BRACKET  
Part#: 50130 or  
50143-HD

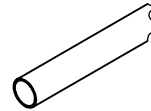

(H)

2"  $\phi$  PROJECTION TUBE  
Part#: 30300 or 30301

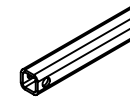

(J)

1" SQ. DIAGONAL  
SUPPORT TUBE  
Part#: 30308 or 30308-HD

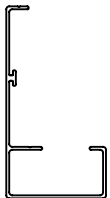

(K)

8" IMPERIAL GUTTER  
Part#: 11153

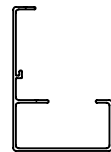

(L)

6" IMPERIAL GUTTER  
Part#: 11144

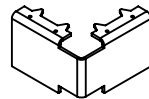

(M)

CORNER BRACKET  
(GUTTER)  
Part#: 11156

(S)

7-3/4" 3M TAPE  
Part# 11158



(N)

CORNER CAP (OUTER)  
Part#: 60670

(T)

2" 3M TAPE  
Part# 11159



(P)

CORNER CAP (INNER)  
Part#: 60699

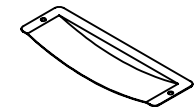

(R)

SCUPPER  
Part#: 90241

# OPTIONAL PARTS LIST

NOTE: QUANTITY OF PARTS WILL VARY BASED ON THE SIZE OF THE AWNING.

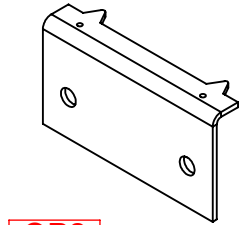
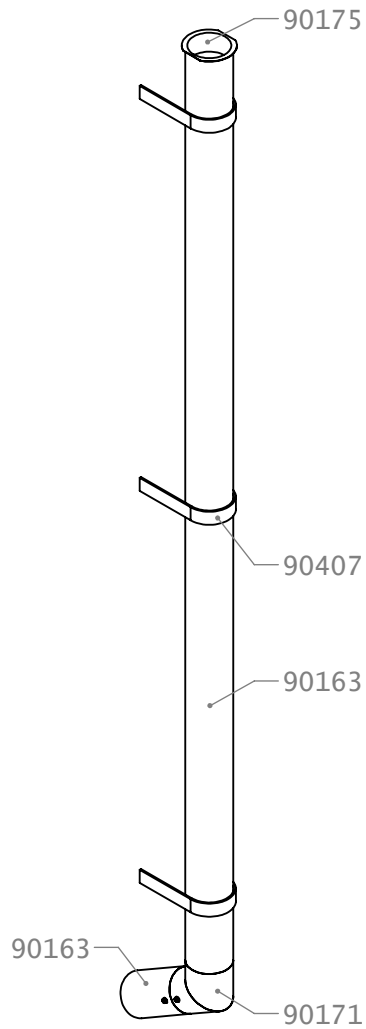

**OP2**  
GUTTER SPLICE UPPER  
Part#: 50156-P

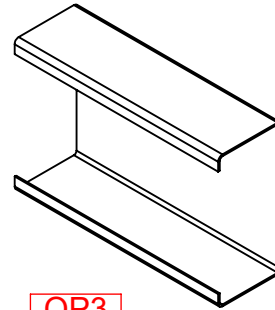

**OP3**  
C-SPLICE GUTTER LOWER  
Part#: 11157

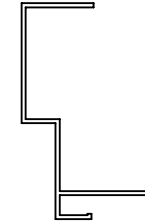

**OP4**  
GUTTER CROWN MOLDING  
Part#: 11145

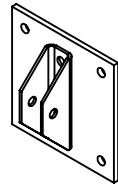

**OP5**  
ESCUTHEON PLATE  
WELDED SQUARE  
Part#: XXXXX

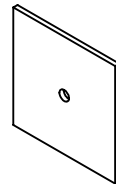

**OP6**  
ESCUTHEON PLATE  
SQUARE 1 HOLE  
Part#: 20965

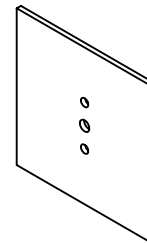

**OP7**  
ESCUTHEON PLATE  
SQUARE 8x8  
Part#: 20975

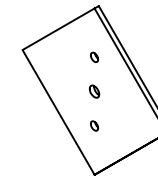

**OP8**  
ESCUTHEON PLATE  
DIAMOND  
Part#: 20977

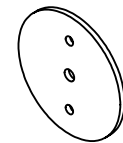

**OP9**  
ESCUTHEON PLATE  
ROUND  
Part#: 20978

**OP1** COMMERCIAL  
DOWNSPOUT

# PARTS LIST HARDWARE

NOTE: 1:1 SCALE ON ALL HARDWARE AA-DD

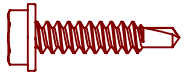

**AA** #8 x 3/4" SCREW  
Part# 20123

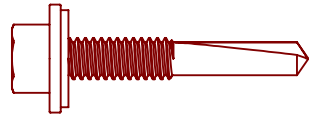

**BB** #12 x 1-1/4" SCREW  
Part# 20201

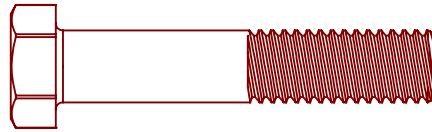

**CC** 3/8"x2" HEX BOLT  
Part# 20414

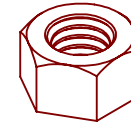

**DD** 3/8"HEX NUT  
Part# 20562  
GALVANIZED NUT  
Part# 20565-G

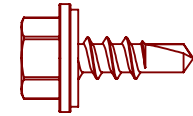

**EE** #14 x 3/4"  
SCREW  
Part# 20151

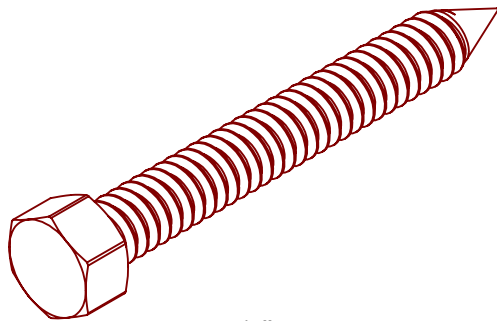

3/8" LAG SCREW  
SUGGESTED WALL ANCHOR FOR WOOD WALLS  
(NOT PROVIDED)

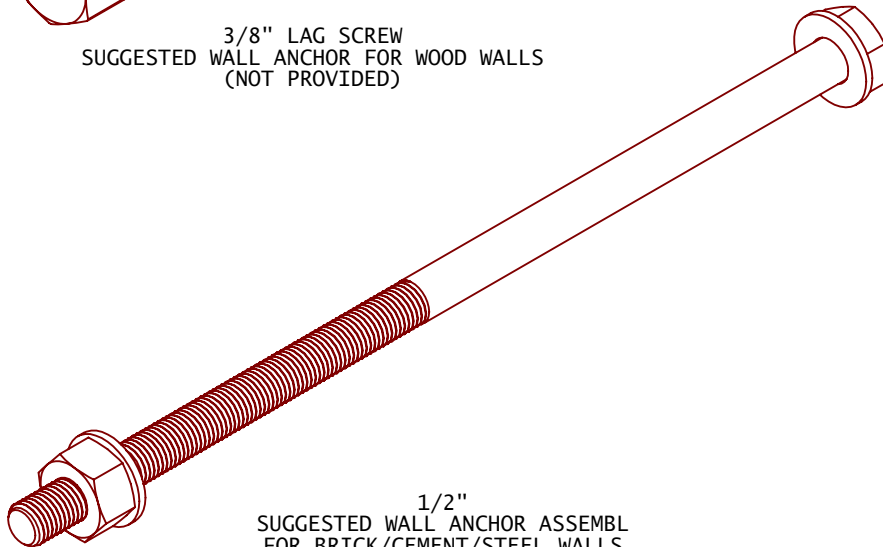

1/2"  
SUGGESTED WALL ANCHOR ASSEMBL  
FOR BRICK/CEMENT/STEEL WALLS  
(NOT PROVIDED)  
SCALE 1:2

## GENERAL INFORMATION ON HARDWARE:

**Load capacity:** The anchor must be capable of supporting the weight of the object being hung on the wall. The load capacity of the anchor should be specified by the manufacturer and matched to the weight of the object.

**Wall material:** The type of anchor used will depend on the material of the wall. For example, anchors for drywall will be different than anchors for concrete or brick walls.

**Anchor size:** The size of the anchor should be appropriate for the size of the screw or bolt being used to attach the object to the wall. The anchor should fit snugly into the hole in the wall.

**Hole size:** The size of the hole in the wall should be appropriate for the size of the anchor being used. The anchor should fit snugly into the hole without being too loose or too tight.

**Installation depth:** The anchor should be installed to the proper depth in the wall. This will ensure that the anchor is securely fastened to the wall and can support the weight of the object being hung.

**Installation method:** The installation method will depend on the type of anchor being used. Some anchors are inserted directly into the wall, while others require a pre-drilled hole. Always follow the manufacturer's instructions for installation.

**Spacing:** The spacing of the anchors will depend on the weight of the object being hung and the load capacity of the anchors being used. Generally, the anchors should be spaced evenly to distribute the weight of the object.

**Environmental conditions:** The anchor must be able to withstand any environmental conditions that may affect it. For example, if the wall is exposed to moisture or high humidity, a corrosion-resistant anchor should be used.

# STEP 1

## GUTTER SPLICE (OPTIONAL)

Complete this step only if gutter (L) is in two or more pieces.

Apply a generous amount of caulk to the back and bottom of the provided gutter splices (F) and (OP3) to prevent leaks. Insert splice half way onto gutter ends to evenly overlap seam.

Attach gutter (L) to gutter splice (F) and (OP3) using (4) #14 x 3/4" screws (EE) as shown. In areas where a splice is needed but *NOT* a Brace, use item (OP2)

## BACK GUTTER ATTACHMENT (WALL)

Mark a level line on the mounting surface at the desired mounting height. Recommended minimum of 10" above any out-swinging door.

Every 24" O.C. use #12 x 1-1/4" screws (BB) to attach gutter to existing wall. Center your screws vertically half the height of the gutter.

Then apply a generous amount of caulk to top edge of gutter to wall.

## ACTIVE PARTS



#14 x 3/4"  
SCREW  
Part# 20151

OP2

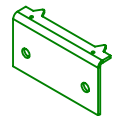

GUTTER  
SPLICE UPPER  
Part#:  
50156-P

OP3

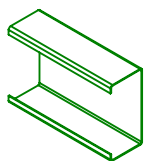

C-SPLICE  
GUTTER LOWER  
Part#:  
11157

F

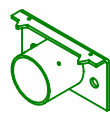

FASCIA  
FITTING  
BRACKET  
Part#:  
50156

L

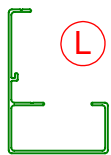

6" IMPERIAL  
GUTTER  
Part#:  
11144

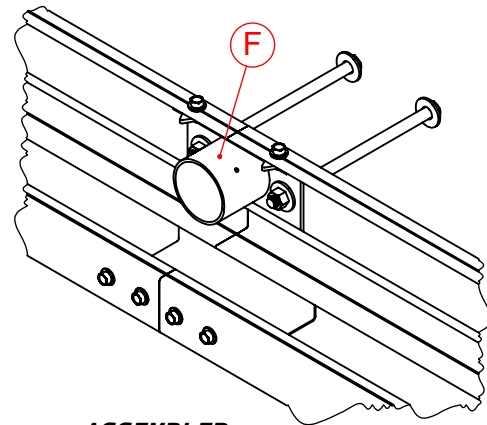

ASSEMBLED  
DETAIL VIEW  
SPLICE W/  
BRACE

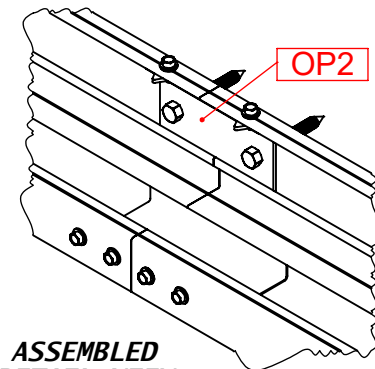

ASSEMBLED  
DETAIL VIEW  
SPLICE W/  
NO  
BRACE

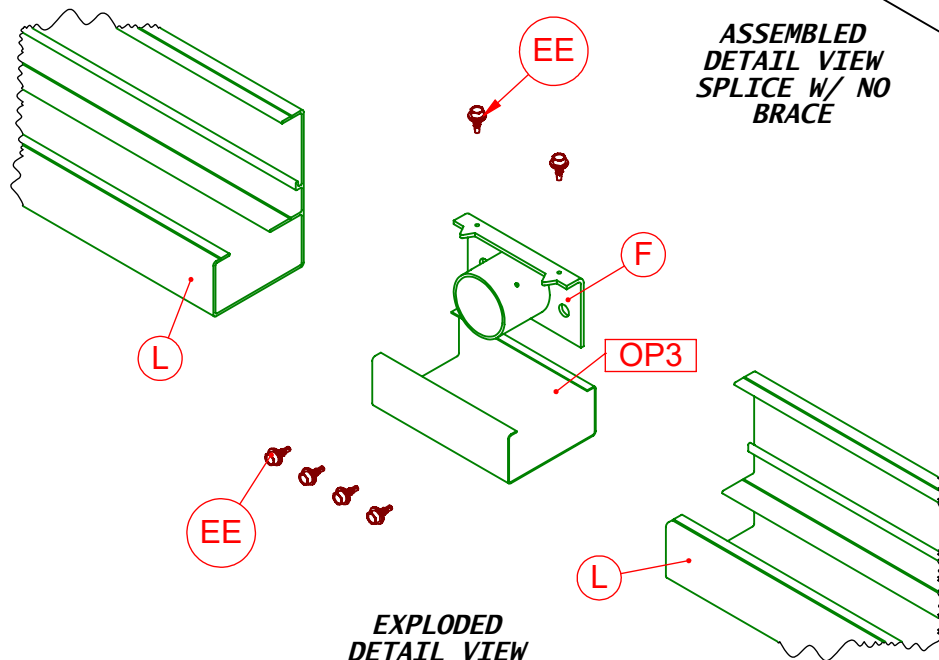

EXPLODED  
DETAIL VIEW

# STEP 1A

## WALL BRACKET ATTACHMENT

REFER TO PAGE (5) BEFORE INSTALLING FOR GENERAL GUIDELINES ON MOUNTING HARDWARE

Start by marking mounting locations on existing wall. Use bolt pattern (shown right) in detail to mark holes in *Back Gutter (L)*. Drill proper holes for suggested anchoring hardware. When drilling into a Block or Steel wall use suggested Anchor Bolts with washers and lock tight nuts. When drilling into a wood wall use suggested lag screws.

*All hardware info is on page (5).*

Minimum anchor capacity for standard load models is 800 lbs. shear strength and 800 lbs. pull-out strength. Higher capacity anchors may be required for higher load models.

12" - 24" on center, depending on wall stud spacing. Minimum anchor capacity for standard load models is 350 lbs. shear strength.

*NOTE: Review the Safety Information on page 1&5 on your local building codes for anchor bolt requirements.*

### ACTIVE PARTS

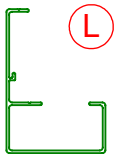

6" IMPERIAL GUTTER  
Part#: 11144

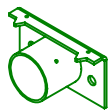

FASCIA FITTING BRACKET  
Part#: 50156



WALL MOUNTING BRACKET  
Part#: 50128 or 50178-HD

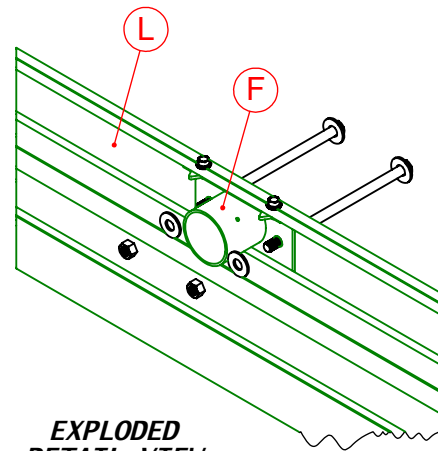
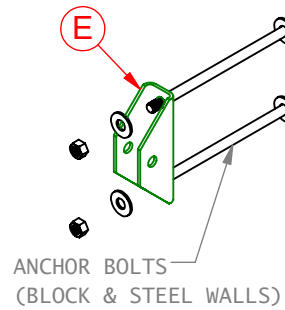
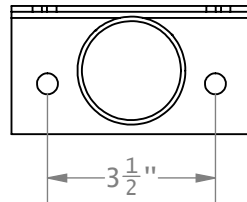

EXPLODED  
DETAIL VIEW

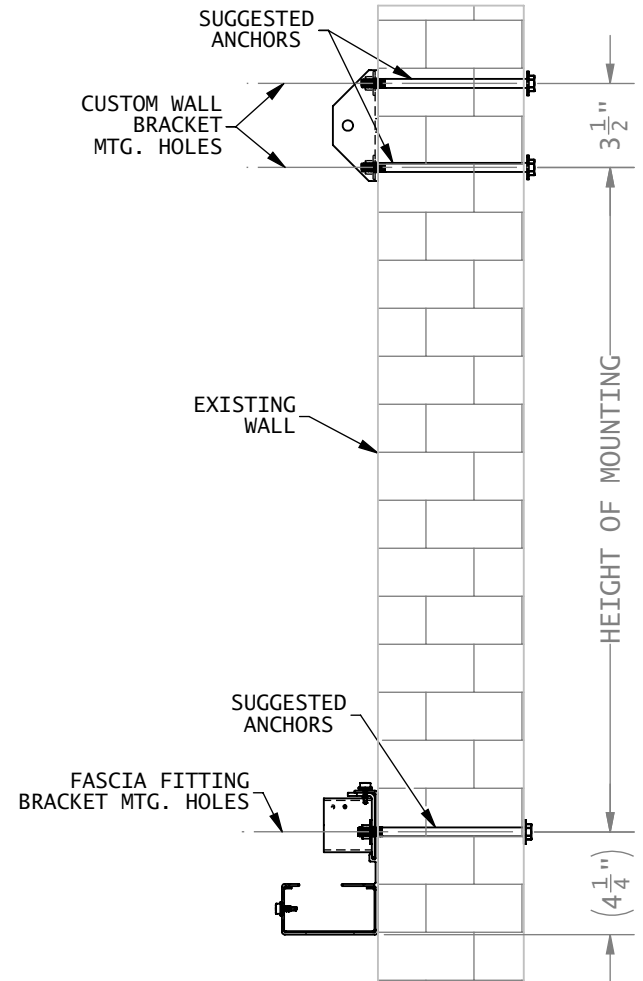

ASSEMBLED  
DETAIL VIEW

## STEP 1B

### WALL BRACKET ATTACHMENT

REFER TO PAGE (5) BEFORE INSTALLING FOR GENERAL GUIDELINES ON MOUNTING HARDWARE

Start by marking mounting locations on existing wall. Use bolt pattern (shown right) in detail to mark holes in *Back Gutter (L)*. Drill proper holes for suggested anchoring hardware. When drilling into a Block or Steel wall use suggested Anchor Bolts with washers and lock tight nuts. When drilling into a wood wall use suggested lag screws.

*All hardware info is on page (5).*

Minimum anchor capacity for standard load models is 800 lbs. shear strength and 800 lbs. pull-out strength. Higher capacity anchors may be required for higher load models.

12" - 24" on center, depending on wall stud spacing.

Minimum anchor capacity for standard load models is 350 lbs. shear strength.

**NOTE:** Review the Safety Information on page 1&5 on your local building codes for anchor bolt requirements.

### ACTIVE PARTS

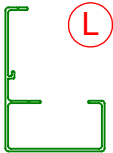

6" IMPERIAL GUTTER  
Part#: 11144

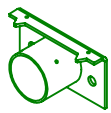

FASCIA FITTING BRACKET  
Part#: 50156



WALL MOUNTING BRACKET  
Part#: 50128 or 50178-HD

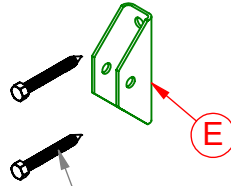
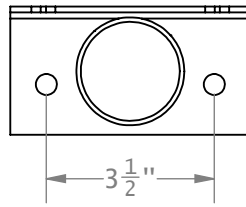

LAG SCREWS  
(WOOD WALLS)

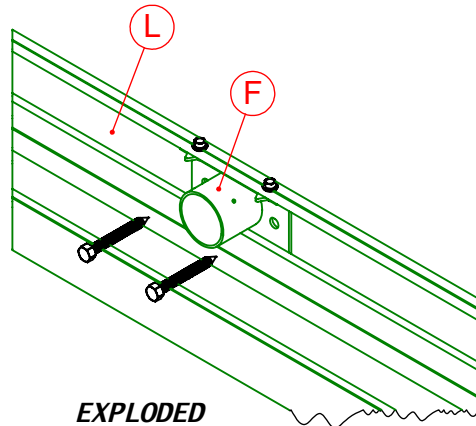

EXPLODED  
DETAIL VIEW

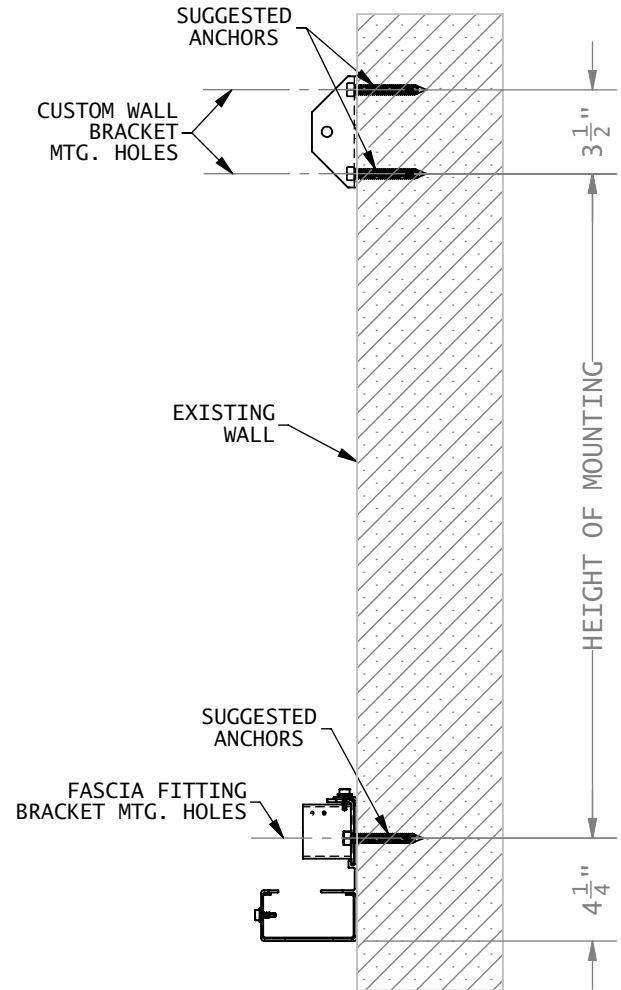

ASSEMBLED  
DETAIL VIEW



## STEP 2

### HORIZONTAL BRACE ATTACHMENT

Start by sliding *Horizontal Bar (H)* into back wall *fascia bracket (F)*. Once positioned pre-drill holes for back mounting hardware (BB) into Bar (H). Fasten Bar. Then slide on front *Slide Bracket (G)*, leave loose. Then attach another Fascia Bracket (F) same procedure as the back Fascia Bracket attachment. Leave front Fascia bracket loose until ready for front gutter install *Step 4*. Repeat steps for all braces.

### ACTIVE PARTS

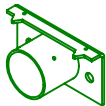

(F)

FASCIA FITTING BRACKET  
Part#: 50156

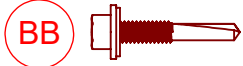

(BB)

#12 x 1-1/4" SCREW  
Part# 20201



(G)

SLIDE FITTING BRACKET  
Part#: 50130 or 50143-HD

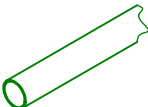

(H)

2"  $\phi$  PROJECTION TUBE  
Part#: 30300 or 30301

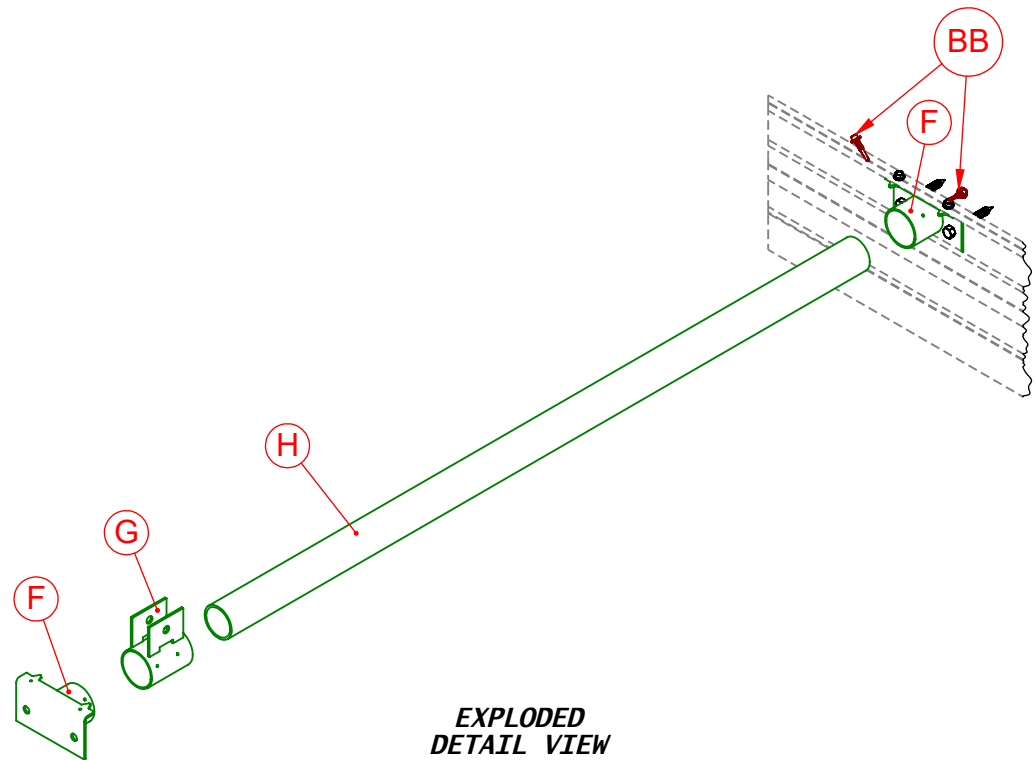
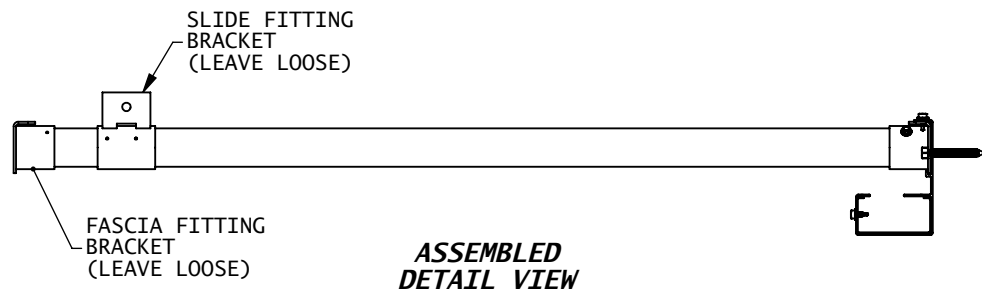



# STEP 3

## DIAGONAL BRACE ATTACHMENT

Attach Diagonal Brace Item (J) on both ends with Bolt & Nut Items (CC)(DD) into Wall Bracket (E) and Slide Bracket (G). Once proper slope is set attach (4) Screws (BB) to slide bracket. Prepare for (2) more screws (BB) to be applied to Front Fascia Bracket (F).

### ACTIVE PARTS

- 

**BB**  
#12 x 1-1/4" SCREW  
Part#: 20201
- 

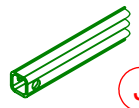
**CC**  
3/8"x2" HEX BOLT  
Part# 20414
- 

**J**  
1" SQ. DIAGONAL SUPPORT TUBE  
Part#: 30308 or 30308-HD
- 

**DD**  
3/8" HEX NUT  
Part# 20562  
GALVANIZED NUT  
Part# 20565-G
- 

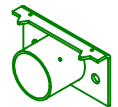
**E**  
WALL MOUNTING BRACKET  
Part#: 50128 or 50178-HD
- 

**F**  
FASCIA FITTING BRACKET  
Part#: 50156
- 

**G**  
SLIDE FITTING BRACKET  
Part#: 50130 or 50143-HD

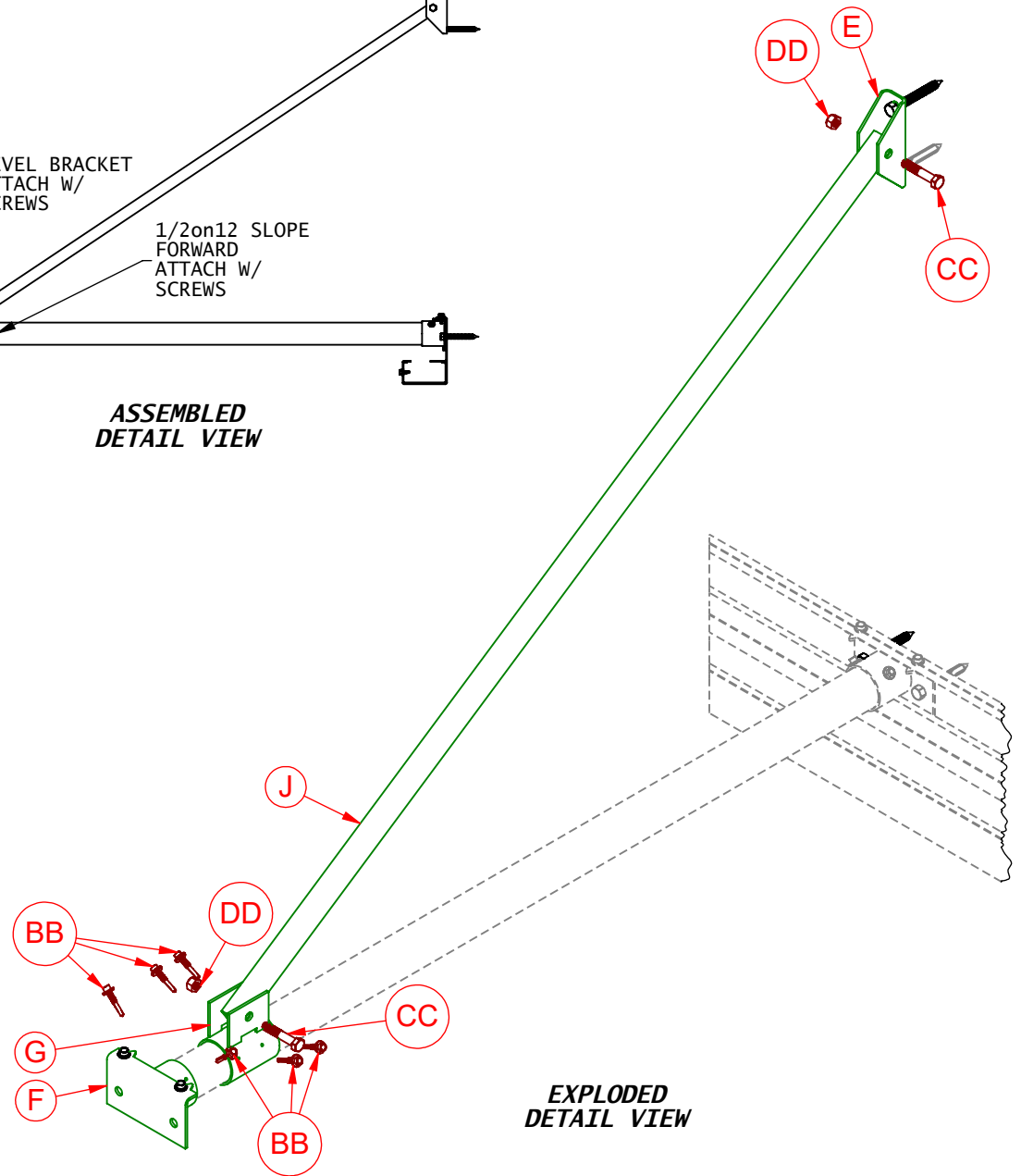
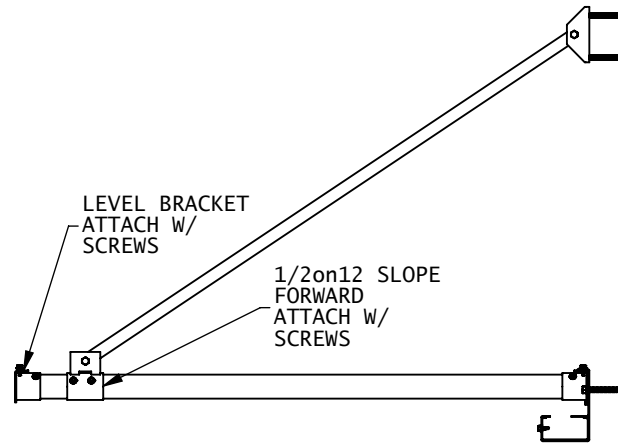

## STEP 4

### FRONT GUTTER ATTACHMENT

Align *Front Gutter* Item (L) same distance from the center of *Brace* to end of gutter on wall. Attach Gutter to *Front Fascia Bracket* (F) using *Tek Screws* (BB) shown right.

*Assembled Detail View* shows profile image dimensions identical to View 3 on Product Drawings. Custom dimensions based on ordered products projection.

### ACTIVE PARTS

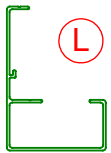

6" IMPERIAL  
GUTTER  
Part#: 11144

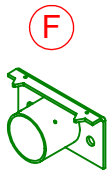

FASCIA  
FITTING  
BRACKET  
Part#: 50156



#14 x 3/4"  
SCREW  
Part# 20151

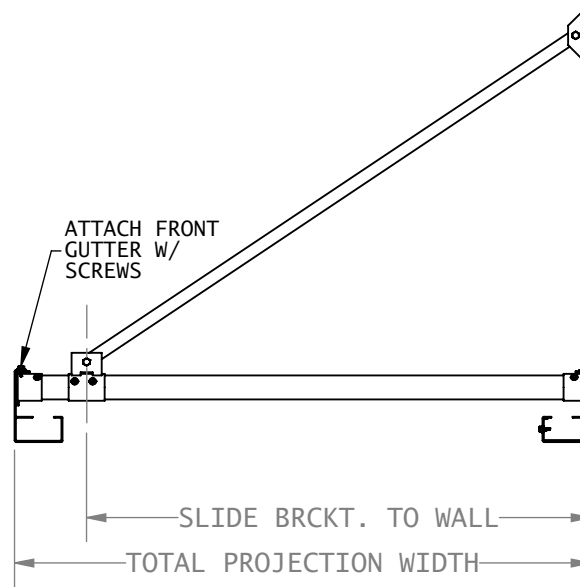

**ASSEMBLED  
DETAIL VIEW**

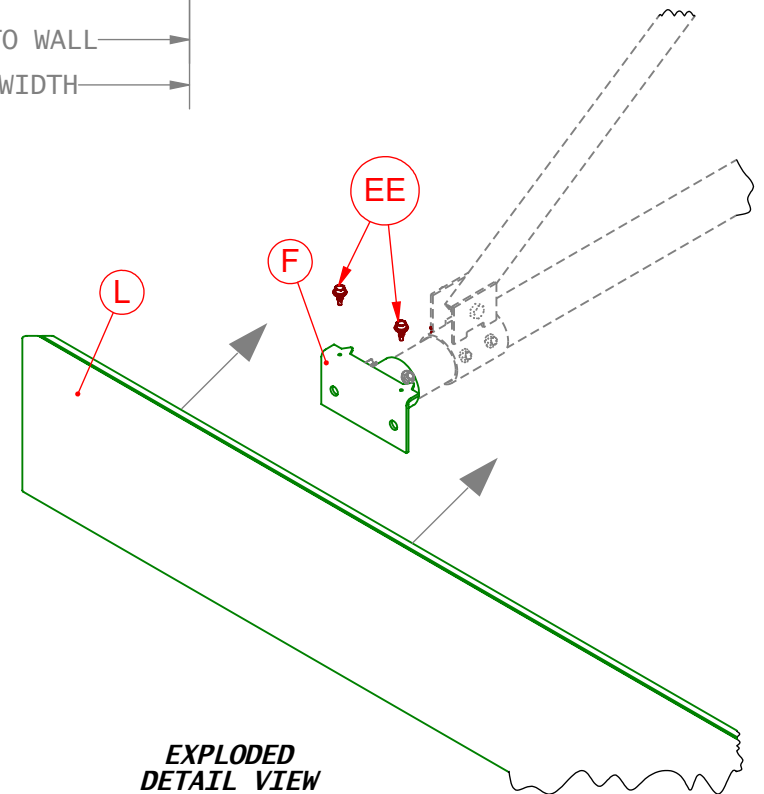

**EXPLODED  
DETAIL VIEW**

## STEP 5

### PROJECTION GUTTER (FIRST)

Attach Corner bracket Item (M) on both ends of projection gutter as shown. Use Tek Screws Item (EE) in pre-drilled holes in bracket to secure to top gutter lip. Prefit into Back n Front Gutter (Longer) to ensure bracket spacing allows corner seam to be flush before attaching screws Item (EE). Once fit attach the other (2) screws shown in exploded view.

At this point you may need to use the Ladder, Stilts, & 2x4 to brace unit out on the front. Some have access to a fork truck which is ideal.

### ACTIVE PARTS

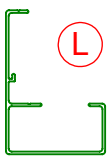

6" IMPERIAL GUTTER  
Part#: 11144

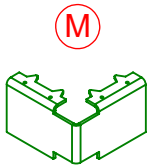

CORNER BRACKET (GUTTER)  
Part#: 11156



#14 x 3/4" SCREW  
Part# 20151

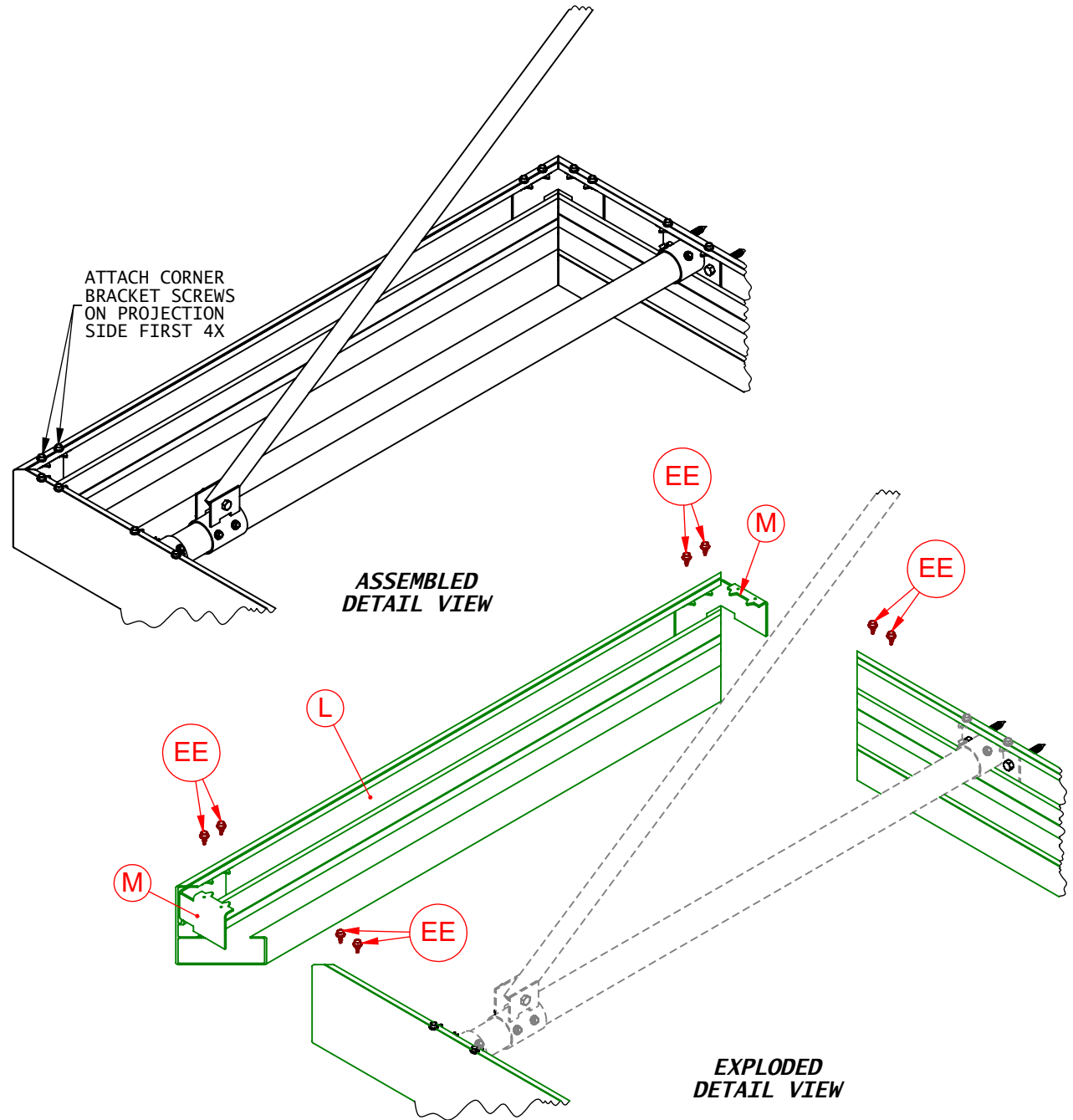

# 8" ROOF PAN

## ROOF PAN ATTACHMENT

Attach Item (B) *Roof Pans* starting from left to right. All pan options overlap or snap lock together. Attach pans using *Tek Screws* Item (AA) shown right. Both ends of pan require screws in a 4 screw pattern shown right. All screws must be applied in the valleys of each pan. (**NOT ON THE RIB UPRIGHTS**). The pans around the wall mounting hardware depending on pan type and placement on gutter may require trimming as well.

## ACTIVE PARTS

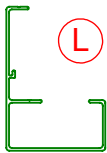

6" IMPERIAL GUTTER  
Part#: 11144

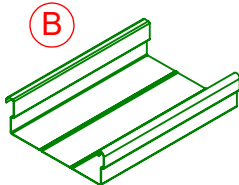

8" FLAT ROOF PAN  
Part#: 10212



#8 x 3/4" SCREW  
Part#: 20123

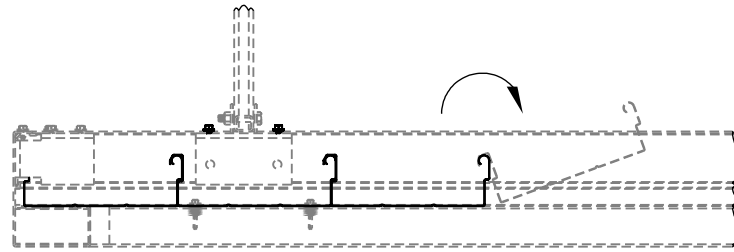

ASSEMBLED  
DETAIL VIEW

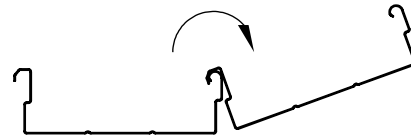

PAN INSTALL  
DETAIL VIEW

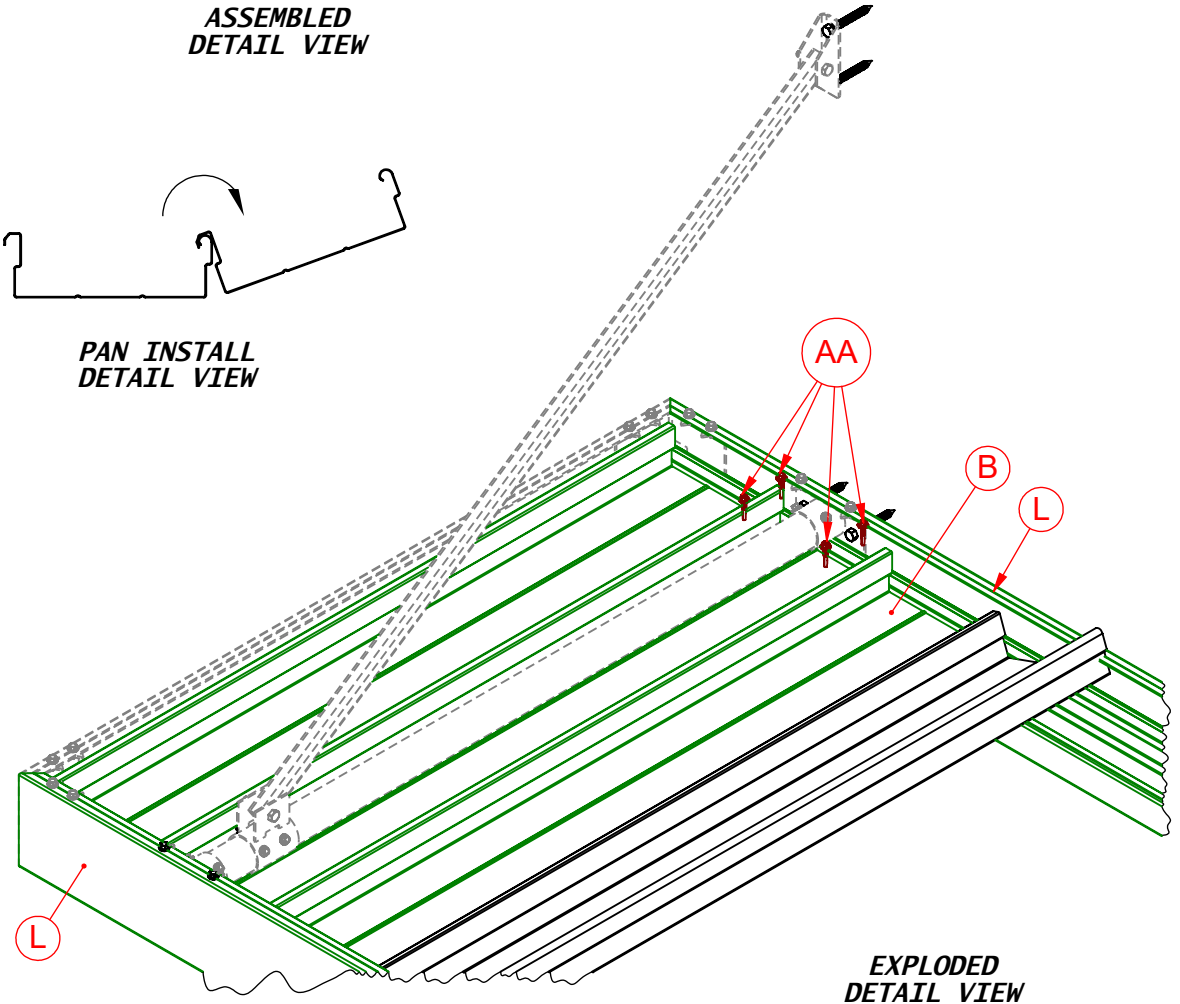

EXPLODED  
DETAIL VIEW

## 6" ROOF PAN

### ROOF PAN ATTACHMENT

Attach Item (A) *Roof Pans* starting from left to right. All pan options overlap or snap lock together. Attach pans using *Tek Screws* Item (AA) shown right. Both ends of pan require screws in a 4 screw pattern shown right. All screws must be applied in the valleys of each pan. (**NOT ON THE RIB UPRIGHTS**). The pans around the wall mounting hardware depending on pan type and placement on gutter may require trimming as well.

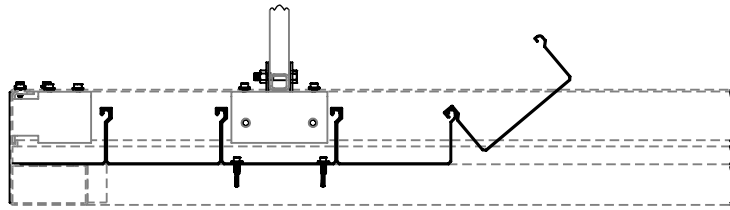

ASSEMBLED  
DETAIL VIEW

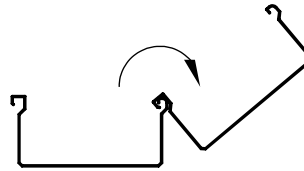

PAN INSTALL  
DETAIL VIEW

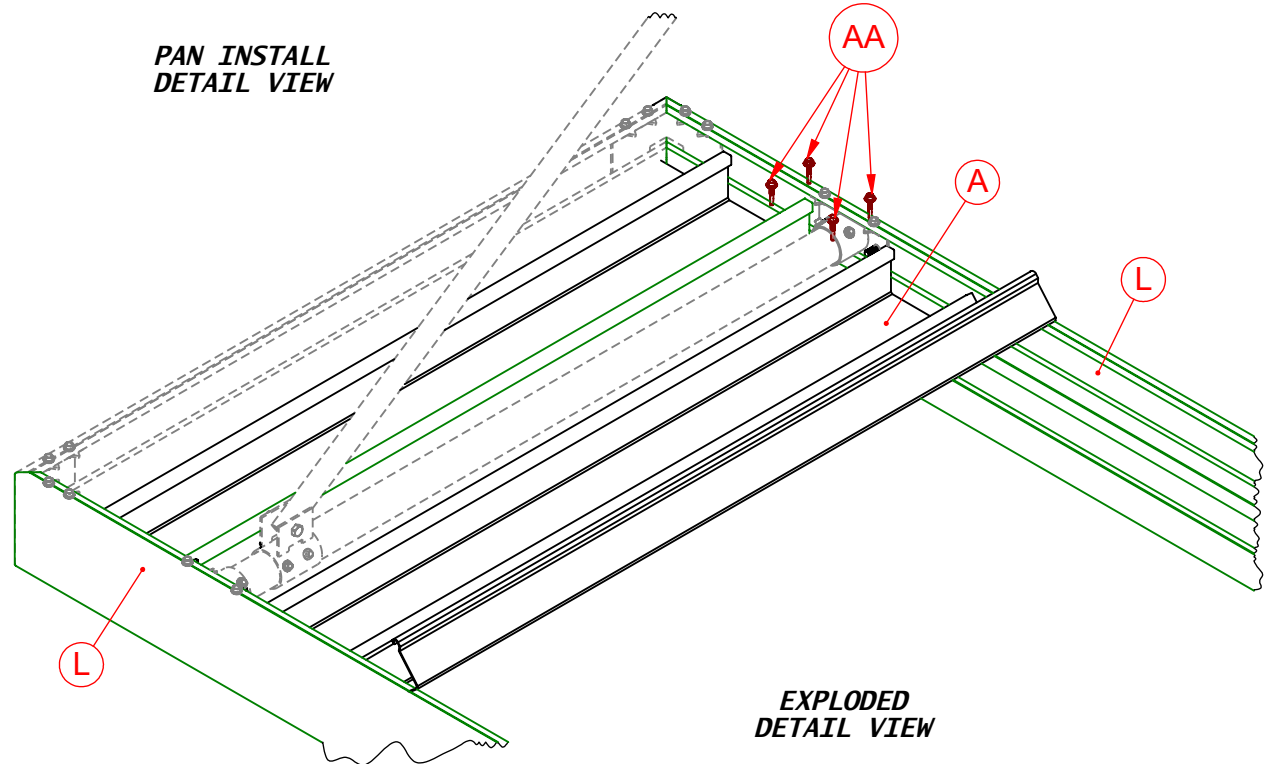

EXPLODED  
DETAIL VIEW

### ACTIVE PARTS

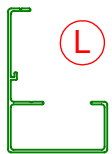

6" IMPERIAL  
GUTTER  
Part#: 11144

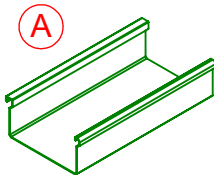

6" EXTRUDED  
FLAT ROOF PAN  
Part#: 11150



#8 x 3/4"  
SCREW  
Part# 20123

## V STYLE ROOF PAN

### ROOF PAN ATTACHMENT

Attach Item (C) *Roof Pans* starting from left to right. All pan options overlap or snap lock together. Attach pans using *Tek Screws* Item (AA) shown right. Both ends of pan require screws in a 4 screw pattern shown right. All screws must be applied in the valleys of each pan. (**NOT ON THE RIB UPRIGHTS**). The pans around the wall mounting hardware depending on pan type and placement on gutter may require trimming as well.

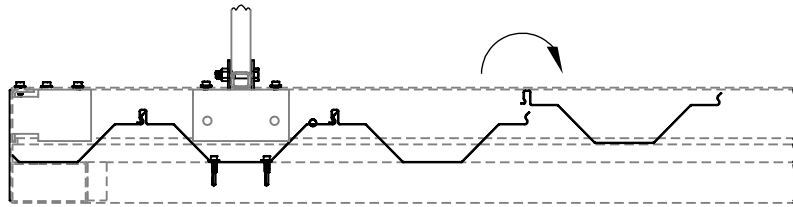

ASSEMBLED  
DETAIL VIEW

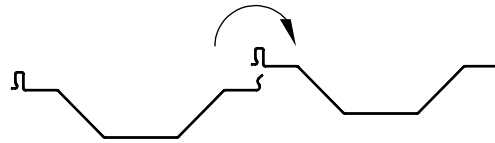

PAN INSTALL  
DETAIL VIEW

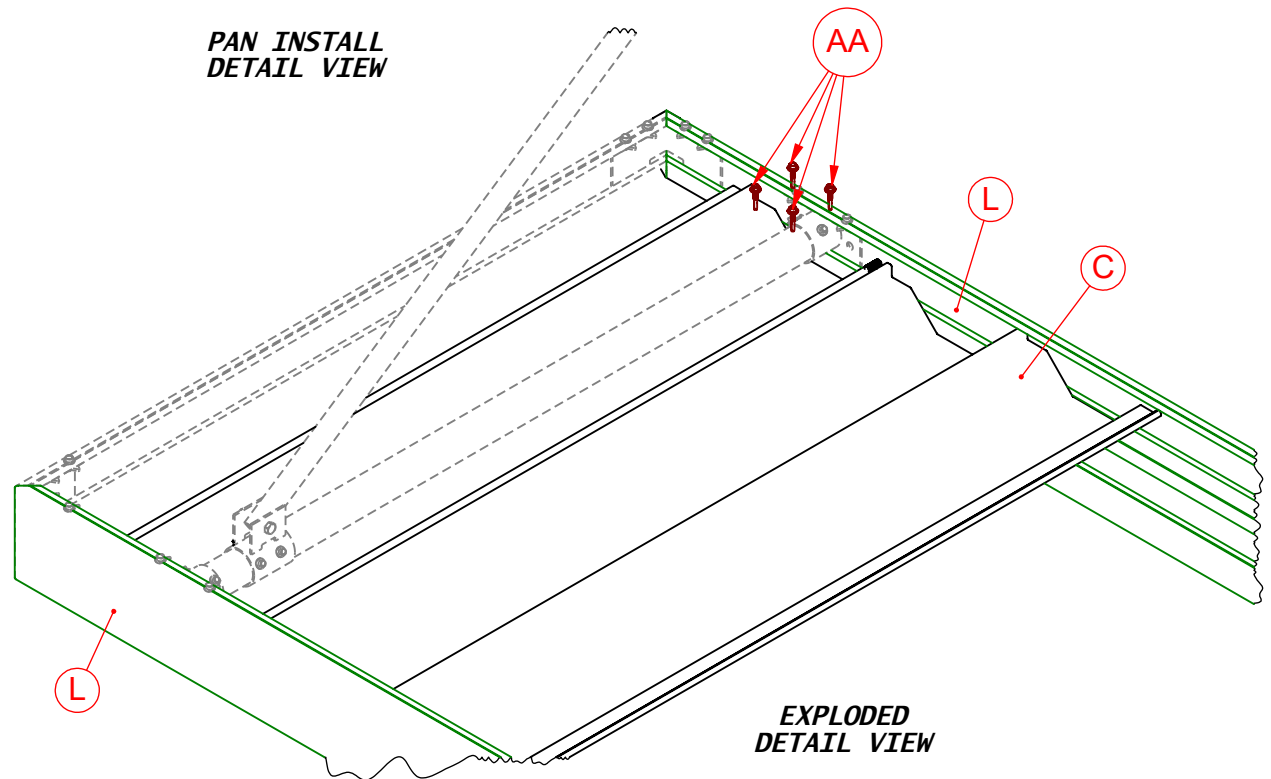

EXPLODED  
DETAIL VIEW

### ACTIVE PARTS

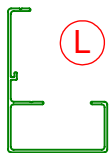

6" IMPERIAL  
GUTTER  
Part#: 11144

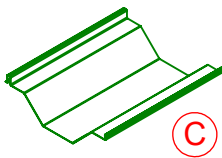

10" V-STYLE  
ROOF PAN  
Part#: 10116



#8 x 3/4"  
SCREW  
Part# 20123

# W STYLE ROOF PAN

## ROOF PAN ATTACHMENT

Attach Item (D) Roof Pans starting from left to right. All pan options overlap or snap lock together. Attach pans using Tek Screws Item (AA) shown right. Both ends of pan require screws in a 4 screw pattern shown right. All screws must be applied in the valleys of each pan. (**NOT ON THE RIB UPRIGHTS**). The pans around the wall mounting hardware depending on pan type and placement on gutter may require trimming as well.

### ACTIVE PARTS

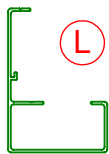

6" IMPERIAL GUTTER  
Part#: 11144

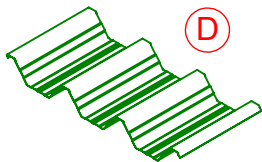

24" W-STYLE ROOF PAN  
Part#: 10307



#8 x 3/4" SCREW  
Part# 20123

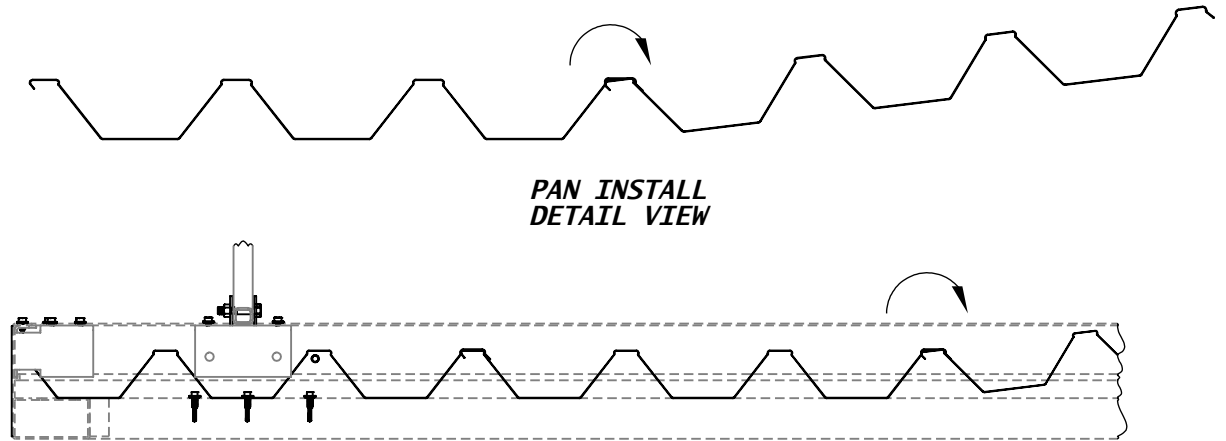

PAN INSTALL  
DETAIL VIEW

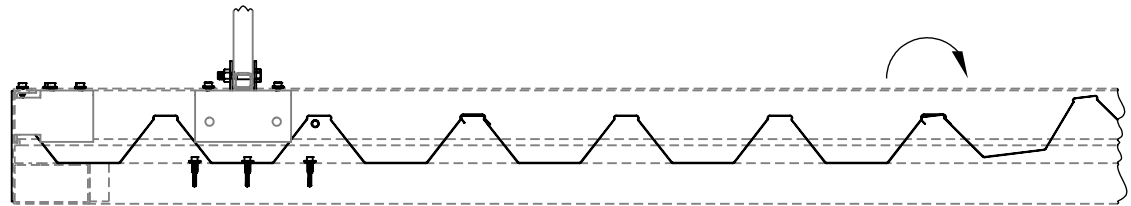

ASSEMBLED  
DETAIL VIEW

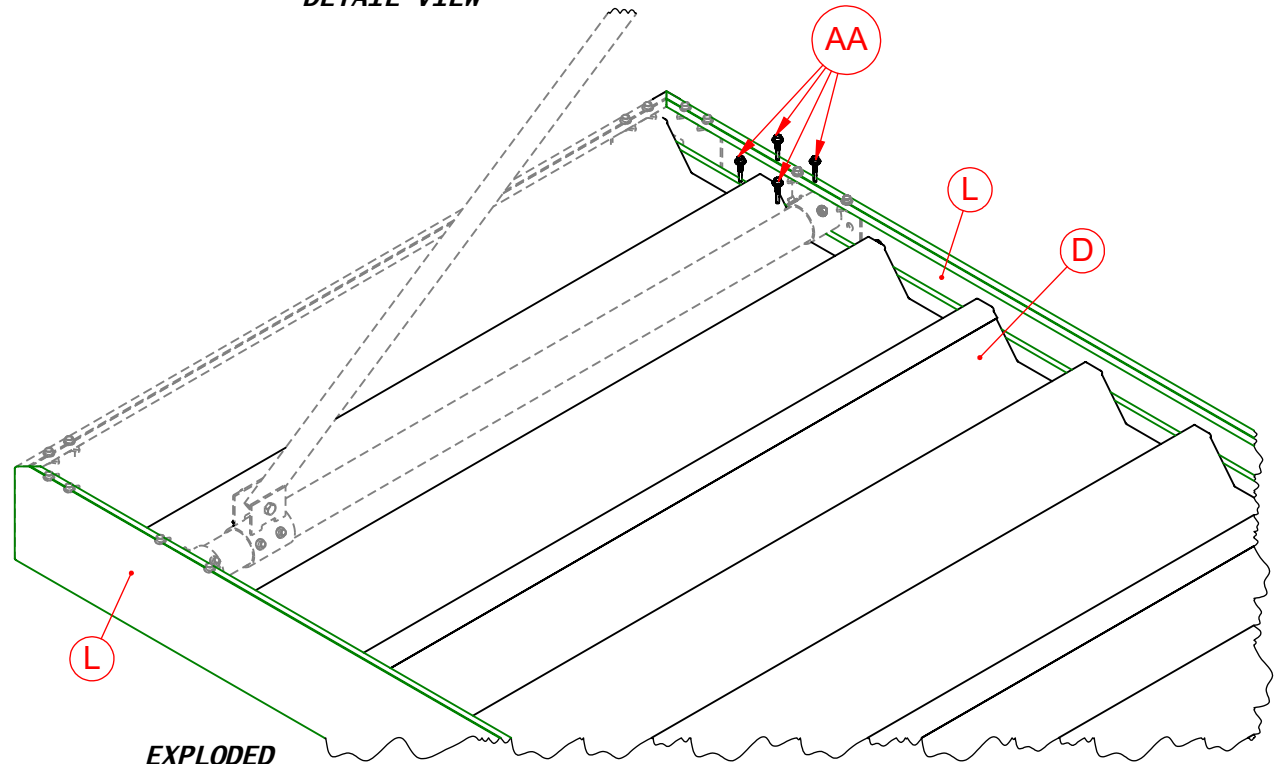

EXPLODED  
DETAIL VIEW



## STEP 7

### PROJECTION GUTTER (LAST)

Attach Corner bracket Item (*M*) on both ends of projection gutter as shown. Use *Tek Screws* Item (*EE*) in pre-drilled holes in bracket to secure to top gutter lip. Prefit into Back n Front Gutter (*Longer*) to ensure bracket spacing allows corner seam to be flush before attaching screws Item (*EE*). Once fit attach the other (*2*) screws shown in exploded view.

At this point you may need to use the Ladder, Stilts, & 2x4 to brace unit out on the front. Some have access to a fork truck which is ideal.

### ACTIVE PARTS

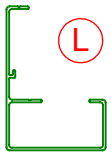

6" IMPERIAL  
GUTTER  
Part#: 11144

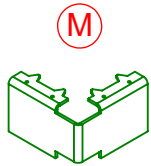

CORNER BRACKET  
(GUTTER)  
Part#: 11156



#14 x 3/4"  
SCREW  
Part# 20151

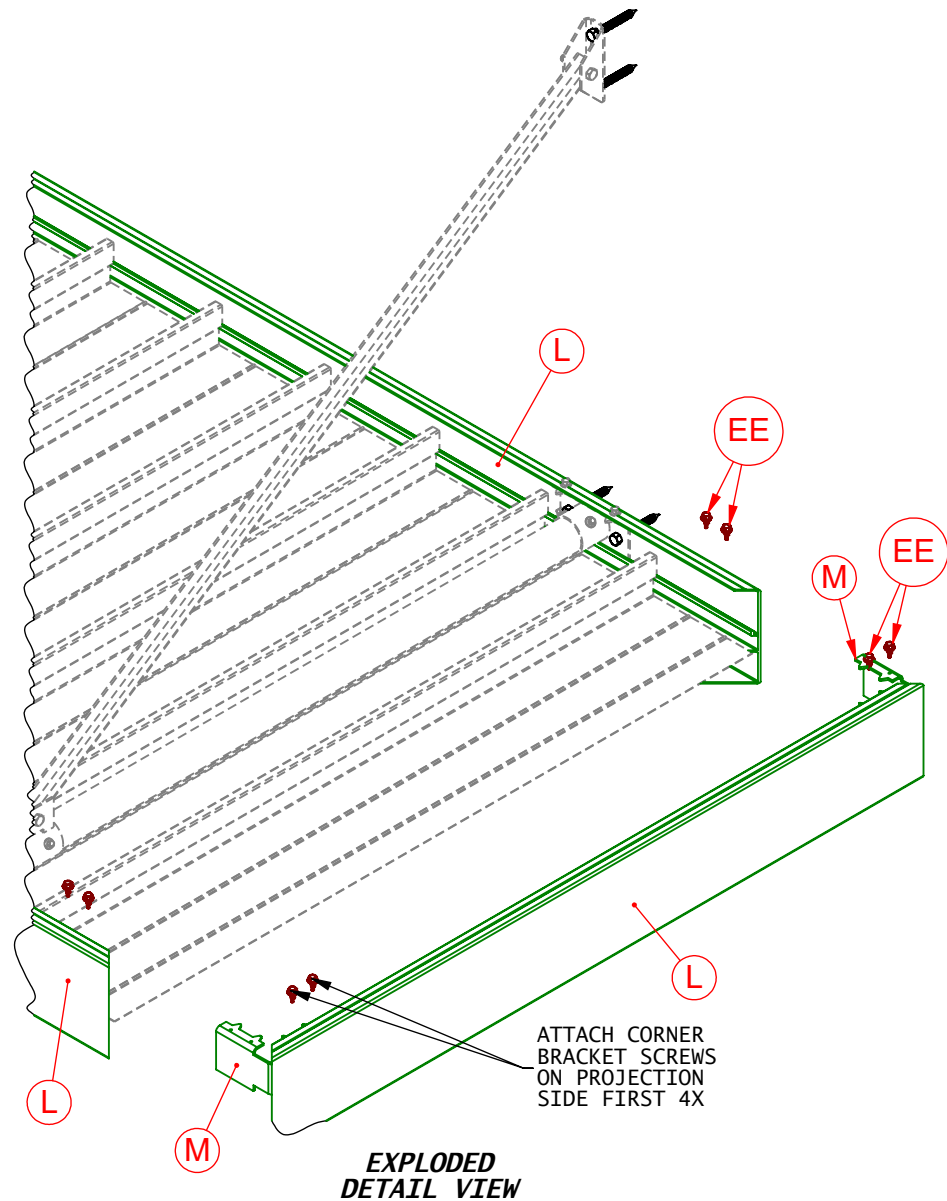

## STEP 8

### CORNER CAPS

Start by peeling the protective layer off the 3M Tape strips for applying to the corner caps. Item (T) strips go on the outside of Corner cap (Inner) (P). Item (S) strips go on the inside verticals of Corner Cap (Outer) (N). Apply gently & steadily to each corner of Gutter (L). Once in place press and hold for a few seconds in all spots to insure the tape adheres properly.

### ACTIVE PARTS

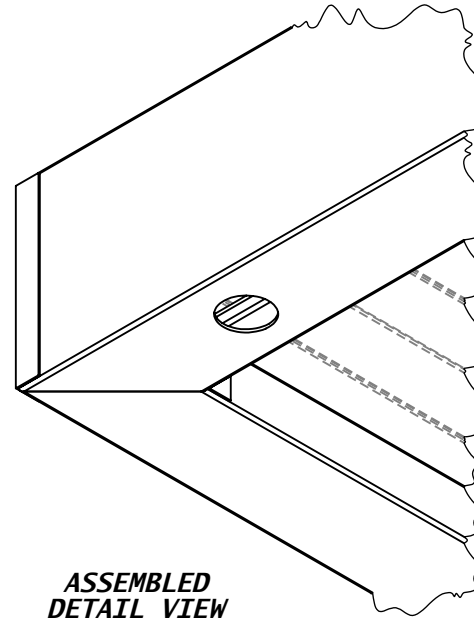
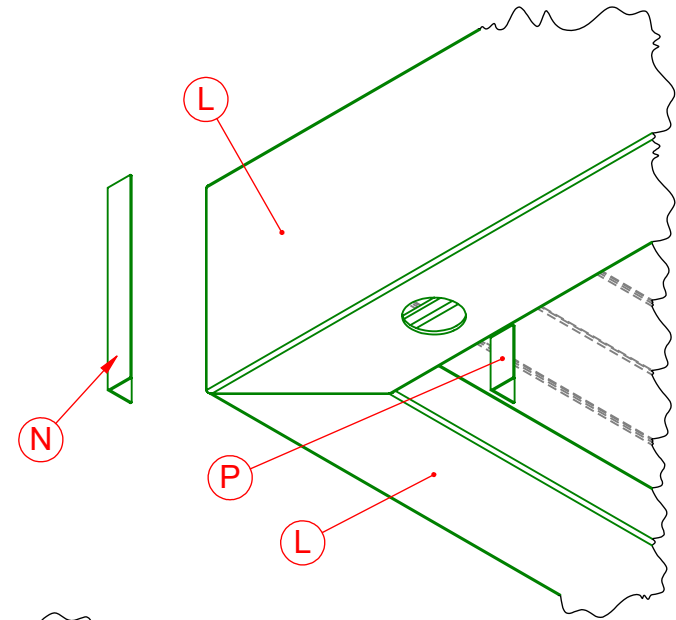
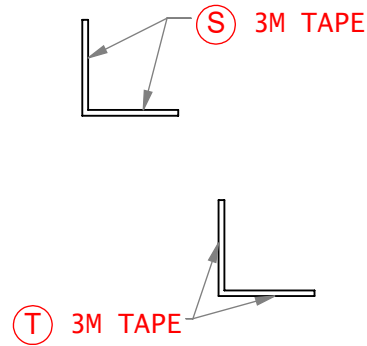
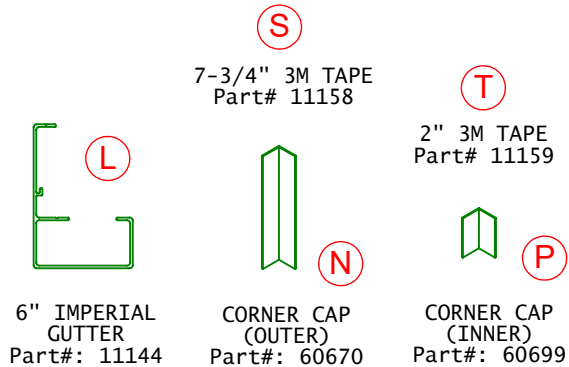

## STEP 9

### WATER DRAINAGE DETAIL

Mark the locations of each Scupper (R) or Downspout (OP1) to be attached to the underside of the Length Gutter (Longer). Start by drilling a 2" hole for Scuppers or a 3" hole for Downspout attachments. Suggested tool Hole Saw.

Once holes are cut debar sharp edges and begin gathering drainage attachments.

Attach Scupper using (2) Screws item (AA) shown to the right.

Attach Downspout using (2) Screws item (AA) also shown.

Make sure and Caulk Silicone all around the outer part of Downspout inlet (item 90175) at gutter.

### ACTIVE PARTS

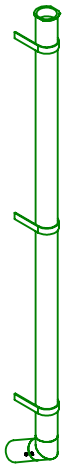

OP1

COMMERICAL  
DOWNSPOUT

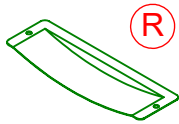

SCUPPER  
Part#: 90241

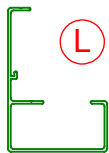

6" IMPERIAL  
GUTTER  
Part#: 11144

AA



#8 x 3/4"  
SCREW  
Part# 20123

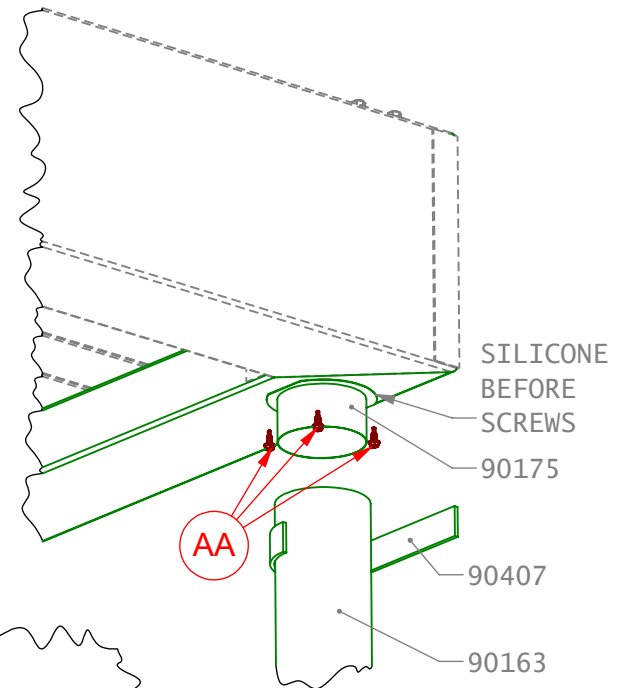
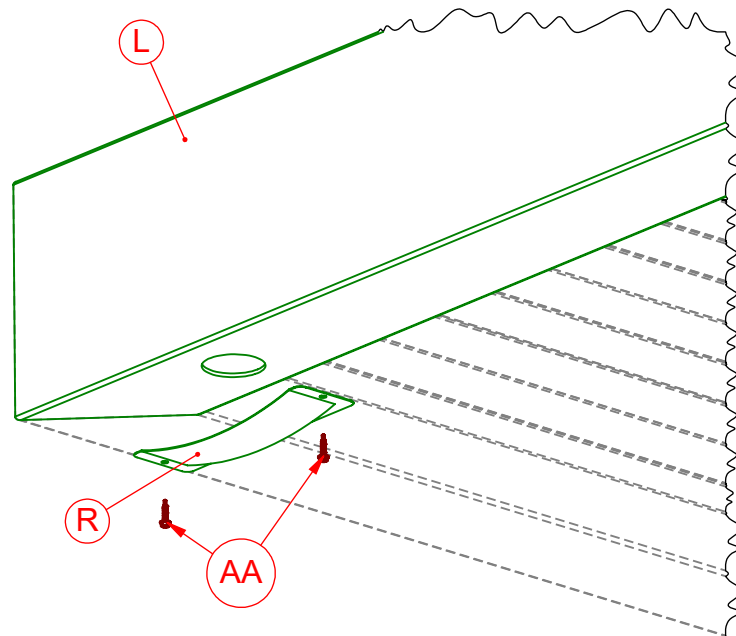

EXPLODED  
DETAIL VIEWS

## Assembly Completed

Remove any metal shavings from the shade structure by sweeping or brushing.  
Be sure to follow the Care and Maintenance instructions shown BELOW.

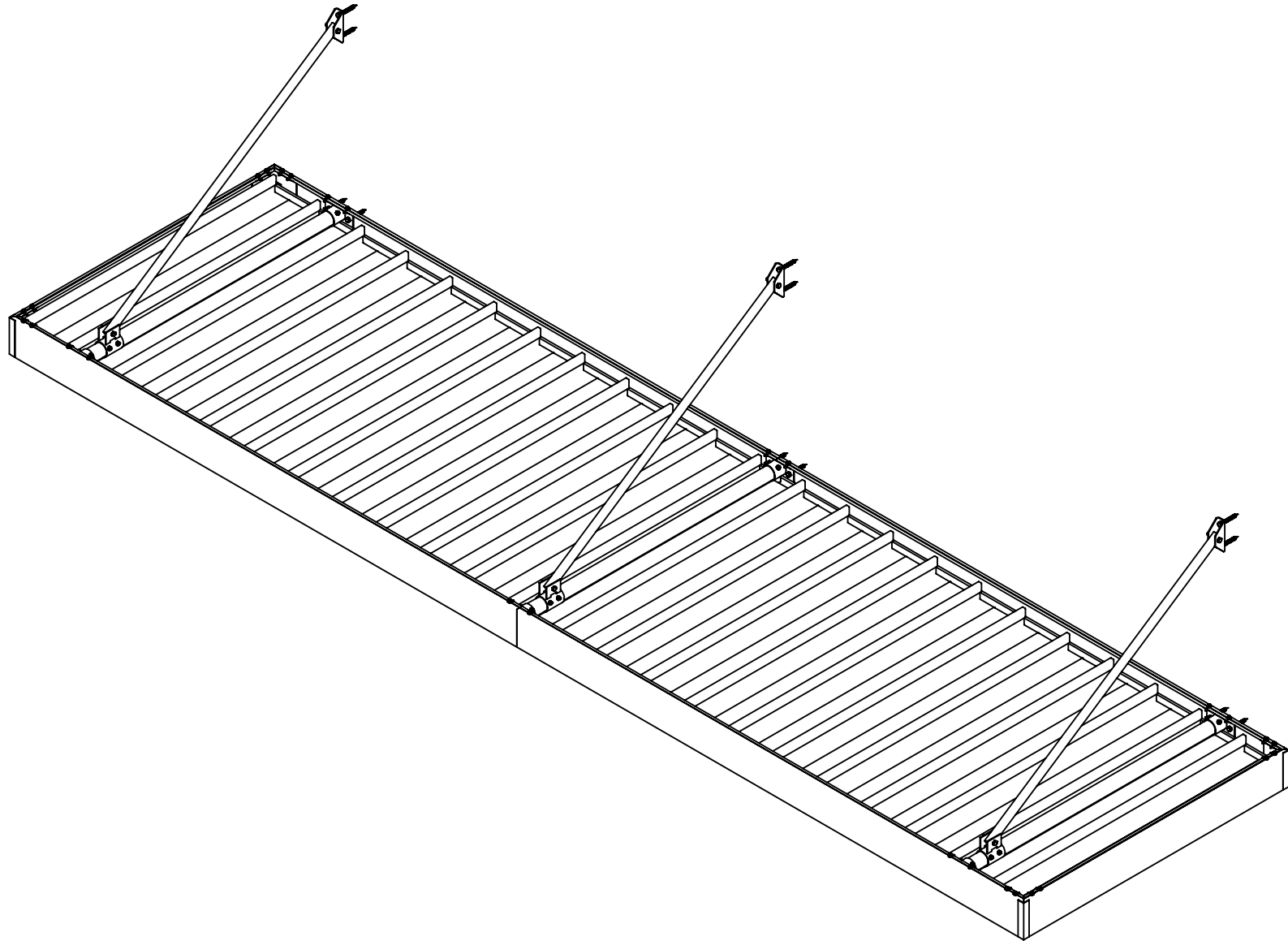

## **WARRANTY**

### What the Warranty Covers:

The manufacturer warrants its products that have been installed in accordance with the installation guidelines, under normal usage conditions, and with proper maintenance as follows:

- Lifetime Limited Warranty on aluminum against material failure and corrosion.
- 25-year Limited Warranty on steel against material failure and defects.
- 10-year warranty against peeling, cracking, blistering, or crazing of the surface finish of aluminum components.
- 10-year Limited Warranty on Sunbrella, Sheerweave, and Solamesh Fabrics.
- 5-year Limited Warranty on Soltis 86 fabrics.
- 1-year warranty against defects in materials and workmanship.

### Period of Coverage:

The warranty period begins on the date of original shipment.

What the Manufacturer Will Do To Correct Problems: If defects or damage of the kind mentioned above should occur within the warranty period, the manufacturer will replace the defective parts only; FOB its plant, upon receiving the written and documented claim of purchaser.

What the Warranty Excludes: Because of normal aging and weathering of materials, it may not be possible to perfectly match the colors of original parts and replacement parts. The manufacturer will not provide or pay for the installation of such replacement parts. The manufacturer shall not be responsible for weather related failures, damages due to faulty installation, misuse or abuse of the product, or for consequential damages, including personal injuries or property damages.

There are no warranties, express or implied, which extend beyond the description on the face hereof.

How Do You Get Service: If you believe that you have a claim under this warranty, submit a copy of your original receipt or other reasonable evidence of the date of purchase, the identity of the product, and photos and a description of the allegedly defective product. Please also include your name, address, and phone number so that a customer service representative can respond to your submission. Ultimate determination of the existence and extent of any claimed defect under this warranty shall be made by the manufacturer in its sole discretion.

## **CARE & MAINTENANCE**

Every 12 months your shade structure should be inspected and maintained by:

- Tightening loose nuts and bolts at all connections.
- Repairing damage to the finish to prevent corrosion.
- Replacing lost or damaged fasteners, brackets, and other parts.
- Replacing brittle or cracked sealer to prevent leaks.
- Removing obstructions and miscellaneous build-up from gutters, eaves, and downspouts.

# Downspout Installation Instructions

## Rear Mounted

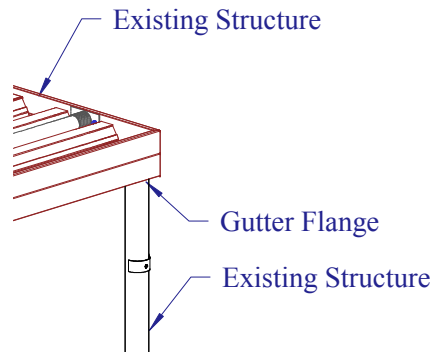

1. Drill 2 3/4" dia. hole in gutter at desired drainage location.
2. Attach Gutter Flange to bottom of Gutter using Tek screws. Next attach Downspout to Gutter Flange using Tek screws.

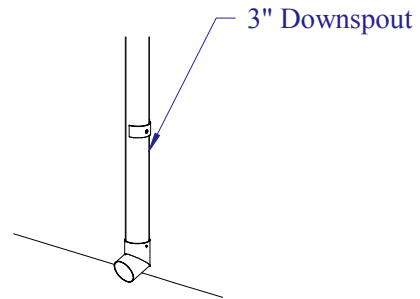

3. Attach Bottom Flange to Downspout using Tek screws.
4. Anchor Downspout to structure with Brackets provided.

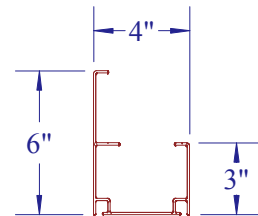
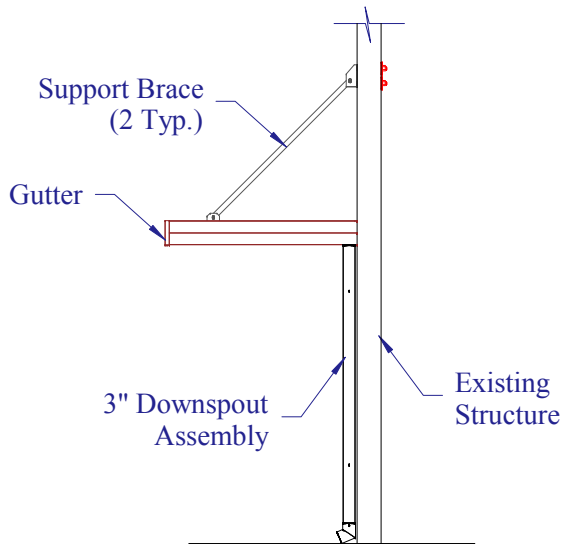

GUTTER PROFILE

# Downspout Installation Instructions

## Front Mounted

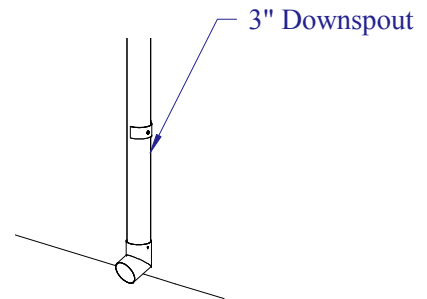
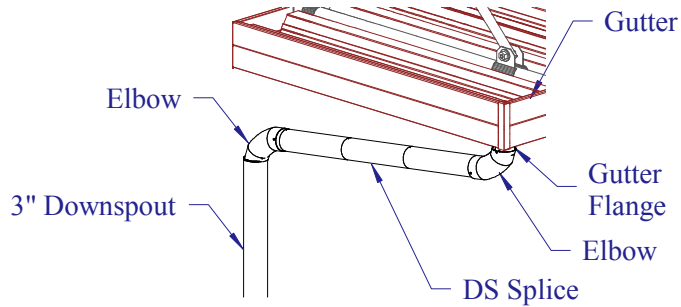

1. Drill 2 3/4" dia. hole in gutter at desired drainage location.
2. Attach Gutter Flange to bottom of Gutter using Tek screws. Next attach Elbow to Gutter Flange using Tek screws. Next attach DS Splice to Elbow and then the Elbow using Tek screws. Attach Downspout to the Elbow using the Tek screws provided.

3. Attach Bottom Flange to Downspout using Tek screws.
4. Anchor Downspout to structure with Brackets provided.

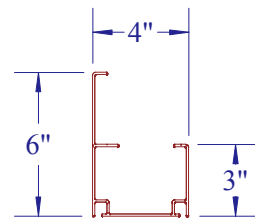
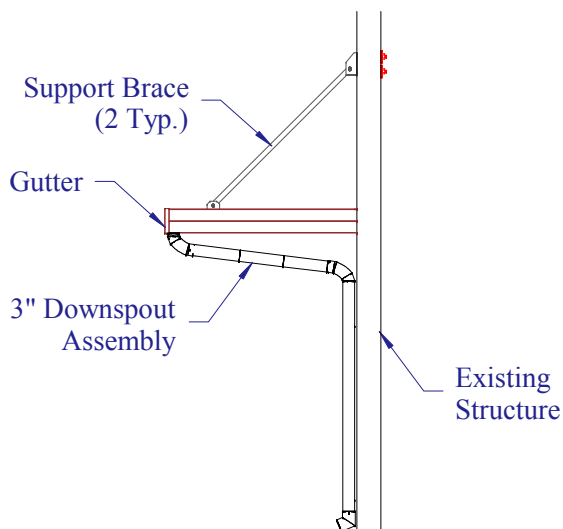

GUTTER PROFILE